



ALLIANCE
TRUCK PARTS

ELECTRICAL SWITCHES



ALL MAKES HEAVY-DUTY
HVAC



Illustrations and photographs used in this catalog may vary slightly from the actual product. Prototype samples are sometimes used for photography. The production parts may vary slightly.

Availability of products shown in this catalog is subject to change without notice.

The numbering system in this catalog is designed for simple, easy to understand and use. This allows for cataloging of “common market” replacement parts based on their size.

The Alliance Truck Parts numbering system is set up systematically: An example is ABP N83 318159. All parts numbers in this program contain “ABP” and “N83”. The ABP simply stands for Alliance Brand Parts and the N83 is a company assigned code, which stands for “air-conditioning parts.” The last 6 digits are assigned based on part and design. Numbered categories are as followed:

- 301000 SERIES, Blower Motors**
Subcategories within Blower Motors include numbers for motor type to include single shaft, double shaft, flange, and assemblies.
301001, single shaft
301002, double shaft
301005, flange
301007, assemblies
- 302000 SERIES, Blower Wheels**
Subcategories within blower wheel include numbers for wheel type to include single or double.
302001, single
302002, double
- 303000 SERIES, Clutches**
Subcategories within clutches include numbers for clutch type to include single groove, double groove, and multi groove.
303001, single groove
303002, double groove
303007, multi groove
- 304000 SERIES, Compressors**
Subcategories within compressors include numbers for compressor brand: CCI, Sanden, GM, Ford, or Seltec.
304001, CCI
304002, Sanden
304006, GM
304007, Ford
304009, Seltec

305000 SERIES, Compressor Accessories

306000 SERIES, Condensers

307000 SERIES, Evaporators

308000 SERIES, Expansion Valves

Subcategories within expansion valves include numbers for expansion valve type: Block valve, internal & external, or orifice.

- 308001, Block Valve**
- 308005, Internal and External**
- 308007, Orifice**

309000 SERIES, Fans & Blades

- 309001, Defrost Fans**
- 309006, Blades**

310000 SERIES, R-12 Fittings

Subcategories within Fittings include numbers for sizes #6, 8, 10, and 12.

- 310006, #6 fitting**
- 310008, #8 fitting**
- 310000, #10 fitting**
- 310002, #12 fitting**

311000 SERIES, R-134A Fittings

Subcategories within Fittings include numbers for specific sizes #6, 8, 10, 12.

- 311006, #6 fitting**
- 311008, #8 fitting**
- 311000, #10 fitting**
- 311002, #12 fitting**

312000 SERIES, O-rings

Subcategories within O-rings include sizes #6, 8, 10, and 12.

- 312006, #6 O-ring**
- 312008, #8 O-ring**
- 312000, #10 O-ring**
- 312002, #12 O ring**

313000 SERIES, Hoses

Subcategories within hoses include hose types: A/C hose, heater hose, duct hose, and air hose.

- 313100, A/C Hose**
- 313300, Heater Hose**
- 313500, Duct Hose**
- 313700, Air Hose**

314000 SERIES, Service ports

314006 SERIES, Adapters

315000 SERIES, Heater cores.

316000 SERIES, Knobs.

317000 SERIES, Louvers

318000 - 318999, Pressure Switches

Subcategories within switches include types: high pressure, low pressure, and trinary and binary.

- 318000, High Pressure**
- 318004, Low Pressure**
- 318009, Tri & Bi**

319000 SERIES, Receiver Driers

Subcategories within receiver driers include types: with switch, without switch, and accumulators.

320000 SERIES, Relays

321000 SERIES, Resisters

322000 SERIES, Electrical switches

323000 SERIES, Thermostatic switches

Subcategories within switches include preset, cable and rotary.

- 323000, Preset.**
- 323004, Cable**
- 323008, Rotary**

324000 SERIES, Water valves

325000 SERIES, Retrofit kits and service kits

326000 SERIES, Chemicals.

327000 SERIES, Service equipment

328000 SERIES, Miscellaneous products

Subcategories within this category include: nuts, rivets, washers, clips, seals, gaskets, bushings, filters, housings, covers, brackets, and tubes.

All parts in this catalog are set up with an Alliance Truck Parts number, ABP N83 000000. In the back of the catalog you will find an extensive cross reference list. This will help link another manufacturers part to an ABP number.

APPLICATIONS

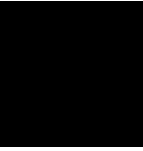

The applications in this section are for reference only. If you have any part discrepancies please check with the original equipment manufacturer.



Ford/Sterling

Description	Alliance No.	OEM No.	ClimaTech No.	International No.
Accumulator	ABP N83 319309	4C4H-19C808-AA / F6HZ-19C836A	N/A	N/A
Blower Motor	ABP N83 301020	PM267CB, XC4H-19805-AA	N/A	N/A
Blower Motor	ABP N83 301276	22061, F1HZ-19805	N/A	N/A
Clutch	ABP N83 303252	D2AZ-2884-A, D4AZ-2884-A	KA1360, KA1410	165338C91
Clutch	ABP N83 303082	C7AZ-2884-B	KA1040	1647566C91
Clutch	ABP N83 303011	C5TZ-2884-C, E5LZ-19D784-A	KA1045	1676660-C91
Clutch	ABP N83 303102	C5UZ-2884-A, C	KA1035	1669746C91
Clutch	ABP N83 303012	D2NN-19D649-A	KA1090	1687801C91
Clutch	ABP N83 303717	F20H-19D786-AA	KA1655	ZGG704028
Compressor	ABP N83 304053	F4HT-19D629-CA	N/A	N/A
Compressor	ABP N83 304582	4862, D0HZ-19986-A	N/A	N/A
Condenser	ABP N83 306880	F6HT-19712A	N/A	ZGG707012

Freightliner

Description	Alliance No.	OEM No.	ClimaTech No.	International No.
Blower Motor	ABP N83 301017, ABP N83 301317	BOA 85 440 50 009	HB1880, HA1870	ZGG19230
Blower Motor	ABP N83 301317	BOA 85 415 00 789	N/A	N/A
Blower Motor	ABP N83 301307	BOA 85 440 50 009, 176140, 3949102	HB1880	ZGG19230
Blower Motor	ABP N83 301308, ABP N83 301327	BOA 85 462 5000 900	N/A	N/A
Blower Motor	ABP N83 301527	BOA-85-462-5000-900, 2809-850-053	N/A	N/A
Blower Switch	ABP N83 322013	F1HZ-19986A	N/A	N/A
Blower Switch	ABP N83 322052	F2UZ-19986B	N/A	N/A
Charge Adapter	ABP N83 325022	N/A	N/A	N/A
Clutch	ABP N83 303051	ABP N83 303051	KA1095	1653480C91, 481800C91
Clutch	ABP N83 303252	ABP N83 303252	KA1040	1647566C91, ZGG11566
Clutch	ABP N83 303102	A22-22498-000	KA1090	1669746C91, 481806C91
Clutch	ABP N83 303242	N/A	N/A	N/A
Clutch	ABP N83 303407	4667-9931	N/A	N/A
Compressor	ABP N83 304081	CFC ET210L 25147R, 25149S	LC1000, LC2000	ZGG15701
Compressor	ABP N83 304031, ABP N83 304061	CFC ET210L 25150	LC2100	2502459C91, 417888C91, 167683C92
Compressor	ABP N83 304543	4417	N/A	N/A
Compressor	ABP N83 304543QS	4417S	N/A	N/A
Compressor	ABP N83 304543S	4417S	N/A	N/A
Compressor	ABP N83 304553	4776	N/A	N/A
Compressor	ABP N83 304573	4430	N/A	N/A
Compressor	ABP N83 304803	4429	N/A	N/A
Compressor	ABP N83 304813	4430	N/A	N/A
Compressor	ABP N83 304823	4431, 4477, 22-47692-000	N/A	N/A
Compressor	ABP N83 304793	4421, 4482	N/A	N/A
Compressor	ABP N83 304783	4417, 4482	N/A	N/A
Compressor	ABP N83 304893	4492, 22-48437-000	N/A	3541235C91, ZGG705017
Compressor	ABP N83 304833	4453, 22-59342-000	N/A	N/A
Compressor	ABP N83 304843	4646, 22-41180-000	N/A	ZGG705008
Compressor	ABP N83 304853	4647, 22-41179-000, 22-59344-000	LE1135, LE1620	2032287C91
Compressor	ABP N83 304873	4672, 22-43374-000, F69-6001-215	N/A	ZGG705009

HIGH VOLUME PARTS

APPLICATIONS

Volvo No.	Mack No.	Red Dot Part No.	Factory No.
RDHRD5115460P	4379-RD5115460	74R5095	RD-5-11546-0P
RDHRD5115790P	4379-RD5115790	73R3072	RD-5-11579-0P
RDHRD5118430P	4379-RD5118430	73R3092	RD-5-11843-0P
RDHRD549670P, 176470	4379-RD549670	75R0452	RD-5-4967-0P
RDHRD549721P, 3949292	4379-RD549721	75R1202	RD-5-4972-1P
RDHRD549840P, V8889022	4379-RD549840	75R3002	RD-5-4984-0P
RDHRD549870P, 176330	4379-RD549870, IMX246	75R3452	RD-5-4987-0P
RDHRD549940P, 176455	4379-RD549940	75R4502	RD-5-4994-0P
RDHRD5103570P	4379-RD5103570	75R4742	RD-5-10357-0P
RDHRD5103030P, 85100868	4379-RD5103030	75R84152	RD-5-10303-0P
RDHRD5108880P	4379-RD5108880	75R89334	RD-5-10888-0P
RDHRD456960P	4379-RD456960	77R6807	RD-4-5696-0P

Volvo No.	Mack No.	Red Dot Part No.	Factory No.
RDHRD5114660P, 176140	4379-RD5114660	73R3002	RD-5-11466-0P
RDHRD5114890P	4379-RD5114890	73R3062	RD-5-11489-0P
176140, 3949102	4379-RD5114660	73R3002	RD-5-11466-0P
RDHRD5114880P	4379-RD5114880	73R3052	RD-5-11488-0P
RDHRD5114880P	4379-RD5114880	73R3052	RD-5-11488-0P
RDHRD5101870P	4379-RD5101870	N/A	RD-5-10187-0P
RDHRD5104400P	4379-RD5104400	71R6253	RD-5-10440-0P
RDHRD579640P	4379-RD579640	75R5815	RD-5-7964-0P
RDHRD549660P, 3949313	4379-RD549660, 1MX41281	75R0302	RD-5-4966-0P
RDHRD549721P, 3949292	4379-RD549721	75R1202	RD-5-4972-1P
RDHRD549870P, 176330, 31160-7760	4379-RD549870, IMX246	75R3452	RD-5-4987-0P
RDHRD5103690P	4379-RD5103690	75R1542	RD-5-10369-0P
RDHRD5107600P	4379-RD5107600	75R1842	RD-5-10760-0P
3949851	4379-RD586370	75R7280	RD-5-8637-0P
1119561, 3949850	4379-RD586380	75R7290	RD-5-8638-0P
RDHRD5112510P	4379-RD5112510	75R81302	RD-5-11251-0P
RDHRD5130621p	4379-RD5130621	N/A	RD-5-13062-1P
RDHRD5130620p	4379-RD5130620	75R82312	RD-5-13062-0P
RDHRD5102670P	4379-RD5102670	75R84232	RD-5-10267-0P
RDHRD5112440P	4379-RD5112440	75R81232	RD-5-11244-0P
RDHRD5112430P	4379-RD5112430	75R81212	RD-5-11243-0P
RDHRD5112440P	4379-RD5112440	75R81232	RD-5-11244-0P
RDHRD5112470P	4379-RD5112470	75R81262	RD-5-11247-0P
RDHRD5112490P	4379-RD5112490	75R81282	RD-5-11249-0P
RDHRD5112510P	4379-RD5112510	75R81302	RD-5-11251-0P
RDHRD5112540P	4379-RD5112540	75R81352	RD-5-11254-0P
RDHRD5112580P	4379-RD5112580	75R81382	RD-5-11258-0P
RDHRD5113150P	4379-RD5113150	75R81462	RD-5-11315-0P
RDHRD5113160P	4379-RD5113160	75R81472	RD-5-11316-0P
RDHRD5113280P	4379-RD5113280	75R81512	RD-5-11328-0P

QUICK REFERENCE

Freightliner

Description	Alliance No.	OEM No.	ClimaTech No.	International No.
Compressor	ABP N83 304883	4709, 22-59343-000	N/A	N/A
Compressor	ABP N83 304903	4819	N/A	N/A
Compressor	ABP N83 304913	4820	N/A	N/A
Compressor	ABP N83 304053	4687, 22-44462-000	N/A	N/A
Compressor	ABP N83 304063	4476, 22-47692-000	N/A	ZGG705013
Compressor	ABP N83 304073	4471, 22-47691-000	N/A	ZGG705012
Compressor	ABP N83 304083	4736, 22-47690-000	N/A	ZGG705011
Compressor	ABP N83 304093	4491, 22-47694-000	N/A	N/A
Compressor	ABP N83 304103	4756, 22-47693-000	N/A	ZGG705014
Compressor	ABP N83 304113	4776	N/A	ZGG705022
Compressor	ABP N83 304123	4818	N/A	N/A
Compressor	ABP N83 304133	4821	N/A	N/A
Compressor	ABP N83 304095	4626, F69-6001-153	LE1140	ZGG19316
Compressor	ABP N83 304503	4428	N/A	N/A
Compressor	ABP N83 304019	488-25011	N/A	1691725C92
Expansion Valve	ABP N83 308011	S10 329 440	EA1065	1676649C1
Expansion Valve	ABP N83 308211	A22-45432-000	EA1365	ZGG19226
Expansion Valve	ABP N83 308009, ABP N83 308211	BOA-80-321-00-169	EA1365	ZGG19226
Expansion Valve, Stat Seal	ABP N83 308231	ABP N83 308231		
Expansion Valve, Stat Seal	ABP N83 308241	BOA-80-321-00-269		
Expansion Valve, Stat Seal	ABP N83 308107	327302, A4965		
Expansion Valve, Stat Seal	ABP N83 308117	BOA-A93674		
Fan	ABP N83 309181	N/A	N/A	N/A
Filter	ABP N83 328375	22-46891-000, VCC36000006	N/A	N/A
Heater Water Valve	ABP N83 324580	867405	MA11100, MA1110	N/A
Louver	ABP N83 317002	N/A	N/A	N/A
Louver	ABP N83 317005	N/A	N/A	N/A
Louver	ABP N83 317006	N/A	N/A	N/A
Pressure Switch(Binary)	ABP N83 318229	A22-43249-000	N/A	N/A
Receiver Drier	ABP N83 319685	088193-00	N/A	N/A
Receiver Drier	ABP N83 319695	088215-02	N/A	N/A
Receiver Drier	ABP N83 319744	088539-00	N/A	N/A
Receiver Drier	ABP N83 319584	088538-00	N/A	ZGG712010
Receiver Drier	ABP N83 319047	088321-00	N/A	N/A
Receiver Drier	ABP N83 319725	088293-00	N/A	N/A
Receiver Drier	ABP N83 319665	088537-00	N/A	N/A
Receiver Drier	ABP N83 319624	088536-00	JA2020	ZGG19139
Receiver Drier	ABP N83 319625	088536-00	N/A	N/A
Receiver Drier	ABP N83 319614	088397-01	JA1885	ZGG19138
Receiver Drier	ABP N83 319615	088335-00	N/A	N/A
Receiver Drier	ABP N83 319735	088337-00	JA1740	ZGG19135
Receiver Drier	ABP N83 319027	088324-01	N/A	N/A
Receiver Drier	ABP N83 319315	088343-00	JA2055	N/A
Relay (Actuator)	ABP N83 301459	VCC32000022		
Resistor	ABP N83 321240	N/A	N/A	N/A
Resistor	ABP N83 321250	N/A	N/A	N/A

HIGH VOLUME PARTS

Volvo No.	Mack No.	Red Dot Part No.	Factory No.
RDHRD5113310P	4379-RD5113310	75R81552	RD-5-11331-0P
RDHRD5113390P	4379-RD5113390	75R81602	RD-5-11339-0P
RDHRD5113400P	4379-RD5113400	75R81612	RD-5-11340-0P
85100868	4379-RD5103030	75R84152	RD-5-10303-0P
85100870	4379-RD5102620	75R84162	RD-5-10262-0P
85100871	4379-RD5102630	75R84172	RD-5-10263-0P
85100872	4379-RD5102640	75R84182	RD-5-10264-0P
RDHRD5102650P	4379-RD5102650	75R84192	RD-5-10265-0P
85100874	4379-RD5102660	75R84212	RD-5-10266-0P
85100876	4379-RD5102670	75R84232	RD-5-10267-0P
RDHRD5102680P	4379-RD5102680	75R84252	RD-5-10268-0P
RDHRD5102690P	4379-RD5102690	75R84262	RD-5-10269-0P
8022507	4379-RD575220	75R8432	RD-5-7522-0P
RDHRD5107370P	4379-RD5107370	75R84632	RD-5-10737-0P
RDHRD558760P	4379-RD558760	75R8512	RD-5-5876-0P
3916657	4379-RD568681	71R8301	RD-5-6868-1P
3949281	4379-RD5101790	N/A	RD-5-10179-0P
3916182	4379-RD575670	71R8370	RD-5-7567-0P
RDHRD5109030P	4379-RD5109030	71R8451	RD-5-10903-0P
RDHRD5125200P	4379-RD5125200	71R8453	RD-5-12520-0P
RDHRD5125210P	4379-RD5125210	71R8455	RD-5-12521-0P
RDHRD5125220P	4379-RD5125220	71R8457	RD-5-12522-0P
RDHRD435080P	4379-RD435080	73R8110	RD-4-3508-0P
RDHRD5118360P	4379-RD5118360	78R5430	RD-5-11836-0P
RDHRD5103450P	4379-RD5103450	72R6530	RD-5-10345-0P
RDHRD596400P	4379-RD596400	N/A	RD-5-9640-0P
RDHRD596410P	4379-RD596410	N/A	RD-5-9641-0P
RDHRD596440P	4379-RD596440	N/A	RD-5-9644-0P
RDHRD584330P	4379-RD584330	71R7075	RD-5-8433-0P
RDHRD5111920P	4379-RD5111920	74R2608	RD-5-11192-0P
RDHRD5111930P	4379-RD5111930	74R2668	RD-5-11193-0P
RDHRD5105890P	4379-RD5105890	74R3120	RD-5-10589-0P
RDHRD5115220	4379-RD5115220	74R3129	RD-5-11522-0P
RDHRD5111850P	4379-RD5111850	74R3137	RD-5-11185-0P
RDHRD5111950P	4379-RD5111950	74R3309	RD-5-11195-0P
RDHRD511190P	4379-RD5111900	74R3317	RD-5-11190-0P
3934718	4379-RD5109410	74R3321	RD-5-10941-0P
RDHRD5111890P	4379-RD5111890	74R3323	RD-5-11189-0P
3949278	4379-RD5109440	74R3327	RD-5-10944-0P
RDHRD5111880P	4379-RD5111880	74R3328	RD-5-11188-0P
RDHRD5111960P	4379-RD5111960	74R3331	RD-5-11196-0P
RDHRD5111840P	4379-RD5111840	74R3357	RD-5-11184-0P
RDHRD5111860P	4379-RD5111860	74R3377	RD-5-11186-0P
RDHRD5118620P	4379-RD5118620	71R3577	RD-5-11862-0P
RDHRD5101890P	4379-RD5101890	N/A	RD-5-10189-0P
RDHRD5101900P	4379-RD5101900	N/A	RD-5-10190-0P

APPLICATIONS

Freightliner

Description	Alliance No.	OEM No.	ClimaTech No.	International No.
Resistor	ABP N83 321260	N/A	N/A	N/A
Resistor	ABP N83 321270	N/A	N/A	N/A
Resistor	ABP N83 321280	N/A	N/A	N/A
Switch	ABP N83 322093	N/A	N/A	N/A
Switch	ABP N83 322700	N/A	N/A	N/A

International/Navistar

Description	Alliance No.	OEM No.	ClimaTech No.	International No.
Blower Motor	ABP N83 301421	2500485C1 / 3949261	HA1090	2500485C1
Blower Motor	ABP N83 301025	1669786C1 / 85100164	HA1090	1669786C1/1699291C1
Blower Motor	ABP N83 301781	1699291C1 / 3093425	HA1990	1699291C1 / 3093425
Clutch	ABP N83 303051	481800C91	KA1095	481800C91
Clutch	ABP N83 303007	1687780C92 / 3949295	KA1480	1687780C92
Clutch	ABP N83 303252	1647566C91 / 3949292	KA1040	1647566C91
Clutch	ABP N83 303102	A22-22498-000 / 31160-7760	KA1090	1669746C91, 481806C91
Compressor	-	ER210R-16792, 25200	-	-
Compressor	ABP N83 304031200820C91 / 3949479/417888C91/167683C92		LC2100	200820C91/417888C91/ 167683C92
Compressor	ABP N83 304953	4645, 2003413C91	LE1150, F69-6002-243	2003413C91
Compressor	ABP N83 304853	4647, 4713, 2032287C91	LE1135, F69-6001-253	2032287C91
Compressor	ABP N83 304973	4667, 3579878C1	LE1085,K318-103, F69-6002-114	3579878C1
Compressor	ABP N83 304983	9680, 3541235C91		3541235C91
Compressor	ABP N83 304403	4822, 3551405C1		3551405C1
Compressor	ABP N83 304669	2521496, 3547916C1		3547916C1
Expansion Valve	ABP N83 308011	1696846-C2 / 3916657	EA1065	1676649C2
Expansion Valve	RDH RD3 7822 0	1696846-C3	EA1305	1696846-C3
Expansion Valve	ABP N83 308141	1699955-C1 / 3949398	EA1310	1699955-C1
Filter	ABP N83 328194	97032815	N/A	ZGG720002
Filter	ABP N83 328203	96932817	N/A	ZGG720008
Filter	ABP N83 328214	96932821	N/A	ZGG720006
Filter	ABP N83 328205	96932819	N/A	ZGG720005
Filter	ABP N83 328265	97935113	N/A	481813C1
Filter	ABP N83 328285	97935112-A/M	GD1020	498144C1, ZGG14263, ZGG720007
Filter	ABP N83 328295	1699956C1, 97935114-A/M	N/A	1699956C1
Receiver Drier	ABP N83 319000	1676651C1	N/A	1676651C1
Receiver Drier	ABP N83 319514	085082-00	JA1085	1676653C1
Receiver Drier	ABP N83 319020	088424-01	N/A	1691710C91
Receiver Drier	ABP N83 319110	1676663C1, 18-01800	N/A	1676663C1
Receiver Drier	ABP N83 319911	1693117C1, 3949280, 454613-C1	JA1325, JA1960	1693117C1
Receiver Drier / Accumulator	ABP N83 319159	3542577C2, BOA 80 32300 139	JC2190	3542577C2

Kenworth

Description	Alliance No.	OEM No.	ClimaTech No.	International No.
Blower Motor	ABP N83 301461	203139BSM	N/A	N/A
Blower Motor	ABP N83 301004	HB1610	HB1610	ZGG701019
Blower Motor	ABP N83 301073	203142BSM	HB1935	N/A

HIGH VOLUME PARTS

Volvo No.	Mack No.	Red Dot Part No.	Factory No.
RDHRD5101910P	4379-RD5101910	N/A	RD-5-10191-0P
RDHRD5101930P	4379-RD5101930	N/A	RD-5-10193-0P
RDHRD5101950P	4379-RD5101950	N/A	RD-5-10195-0P
RDHRD5101940P	4379-RD5101940	N/A	RD-5-10194-0P
RDHRD596030P	4379-RD596030	N/A	RD-5-9603-0P

Volvo No.	Mack No.	Red Dot Part No.	Factory No.
3949261	4379-RD551200	73R0512	RD-5-5120-0P
85100164	4379-RD549370	73R2102	RD-5-4937-0P
RDHRD588050P	4379-RD588050	73R2232	RD-5-8805-0P
3949313	4379-RD549660	75R0302	RD-5-4966-0P
3949295	4379-RD580090	75R0612	RD-5-8009-0P
3949292	4379-RD549721	75R1202	RD-5-4972-1P
31160-7760	4379-RD549870	75R3452	RD-5-4987-0P
RDHRD5108260P	4379-RD5108260	75R7265	RD-5-10826-0P
1119561/3949479	4379-RD586380	75R7290	RD-5-8638-0P
RDHRD5113130P	4379-RD5113130	75R81452	RD-5-11313-0P
RDHRD5113160P	4379-RD5113160	75R81472	RD-5-11316-0P
RDHRD5113260P	4379-RD5113260	75R81502	RD-5-11326-0P
RDHRD5113500P	4379-RD5113500	75R81732	RD-5-11350-0P
RDHRD5107380P	4379-RD5107380	75R84622	RD-5-10738-0P
RDHRD5104960P	4379-RD5104960	75R8752	RD-5-10496-0P
3916657	4379-RD568681	71R8301	RD-5-6868-1P
RDHRD378220P	4379-RD378220	71R8310	RD-3-7822-0P
3949398	4379-RD589360	71R8430	RD-5-8936-0P
RDHRD5100770P	4379-RD5100770	78R5236	RD-5-10077-0P
RDHRD5100820P	4379-RD5100820	78R5255	RD-5-10082-0P
RDHRD5100750P	4379-RD5100750	78R5256	RD-5-10075-0P
RDHRD5100810P	4379-RD5100810	78R5257	RD-5-10081-0P
RDHRD5107740P	4379-RD5107740	78R5302	RD-5-10774-0P
RDHRD5107730P	4379-RD5107730	78R5306	RD-5-10773-0P
RDHRD5107750P	4379-RD5107750	78R5308	RD-5-10775-0P
RDHRD535931P	4379-RD535931	74R1706	RD-5-3593-1P
61510-001	4379-RD535930	74R1756	RD-5-3593-0P
RDHRD538430P	4379-RD538430	74R2556	RD-5-3843-0P
RDHRD549550P	4379-RD549550	74R2706	RD-5-4955-0P
3949280	4379-RD549590	74R3450	RD-5-4959-0P
RDHRD5126230P	4379-RD126230	74R5097	RD-5-12623-0P

Volvo No.	Mack No.	Red Dot Part No.	Factory No.
RDHRD582120P	4379-RD582120	73R0222	RD-5-8212-0P
85101275	4379-RD5103370	73R0412	RD-5-10337-0P
RDHRD589220P	4379-RD589220	73R0612	RD-5-8922-0P

Kenworth

Description	Alliance No.	OEM No.	ClimaTech No.	International No.
Blower Motor	ABP N83 301072	20578P	HB1050	1691733C91, 1691704C91
Clutch	ABP N83 303051	K332-62-2, 024 21942	KA1095	481800C91
Clutch	ABP N83 303252	KA1360	KA1360	165338C91
Clutch	ABP N83 303252	KA1040	KA1040	1647566C91
Compressor	ABP N83 304081	ER210L-25149, LC1000, LC2000	LC2000	ZGG15701
Compressor	ABP N83 304061	ER210L-25150, LC2100	LC2100	2502459C91, 417888C91 / 167683C92
Compressor	ABP N83 304853	4647, F69-6001-253	LE1135	2032287C91
Compressor	ABP N83 304344	4660		ZGG705006
Compressor	ABP N83 304973	K318-103	LE1085, F69-6002-114	3579878C1
Compressor	ABP N83 304873	F69-6001-215	F69-6001-215	ZGG705009
Compressor	ABP N83 304394	F69-6002-214, 18-04291	F69-6002-214	N/A
Compressor	ABP N83 304481	Sanden #4425, 4792 for Cat 3406 engine	F69-6000, F69-6002-122	N/A
Compressor	ABP N83 304741	Sanden #4432, 4759 for Detroit S60 series engine	F69-1003, F69-6002-111	N/A
Compressor	ABP N83 304125	4627, LE1145	LE1145	ZGG19296
Compressor	ABP N83 304095	4626, F69-6001-153	LE1140, F69-6001-153	ZGG19316
Compressor	ABP N83 304095	F69-1002, F69-6002-133	F69-1002, F69-6002-133	ZGG19316
Compressor	ABP N83 304363	4664	LE1035	ZGG19370
Compressor	ABP N83 304659	F69-1000, 18-04154	F69-1000	ZGG705129
Expansion Valve	ABP N83 308011	EA1065	EA1065	1676649C1
Expansion Valve	ABP N83 308191	EA1090	EA1090	1676665C1
Expansion Valve	ABP N83 308141	540057BSM	540057BSM	1699955C1
Filter	ABP N83 328225	525507BSM, 94735015-A/M	525507BSM	N/A
Grill Condenser	ABP N83 306535	K122-64	K122-64	N/A
Grill Condenser	ABP N83 306500	K122-81	K122-81	N/A
Grill Condenser	ABP N83 306500	K122-124	K122-124	N/A
Grill Condenser	ABP N83 306305	K122-102	K122-102	N/A
Grill Condenser	ABP N83 306575	K122-125	K122-125	N/A
Grill Condenser	ABP N83 306260	K122-121, RD4 4403 1	K122-121	N/A
Grill Condenser	ABP N83 306580	K137-299-1	K137-299-1	N/A
Grill Condenser	ABP N83 306585	K137-299-2	K137-299-2	N/A
Grill Condenser	ABP N83 306615	K100 Series	K100 Series	N/A
Grill Condenser	ABP N83 306605	K137-300-1	K137-300-1	N/A
Grill Condenser	ABP N83 306610	K137-300-2	K137-300-2	N/A
Receiver Drier	ABP N83 319574	088439-01, F37-6000	F37-6000	ZGG712051
Receiver Drier	ABP N83 319028	088324-01, 02, K251-571, GD1135	GD1135	ZGG19141
Relay (Actuator)	ABP N83 301459	VCC32000022		
Toggle Switch	ABP N83 322003	BA1005	BA1005	N/A

Mack

Description	Alliance No.	OEM No.	ClimaTech No.	International No.
Blower Motor	ABP N83 301004	4379-RD5103370	HA1180, HB1610	ZGG701019
Blower Motor	ABP N83 301097	4379-RD556341	HA1175	ZGG19262
Clutch	ABP N83 303282	4379-RD554860	KA1345	ZGG11207
Compressor	ABP N83 304102	4379-RD570880	LE1260	ZGG13503
Compressor	ABP N83 304241	206RD51M, 20514024, Sanden 4883		

HIGH VOLUME PARTS

APPLICATIONS

Volvo No.	Mack No.	Red Dot Part No.	Factory No.
3949266	4379-RD568010	73R4182	RD-5-6801-0P
3949313	4379-RD549660, 1MX41281	75R0302	RD-5-4966-0P
176470	4379-RD549670	75R0452	RD-5-4967-0P
3949292	4379-RD549721	75R1202	RD-5-4972-1P
3949851	4379-RD586370	75R7280	RD-5-8637-0P
1119561, 3949850	4379-RD586380	75R7290	RD-5-8638-0P
RDHRD5113160P	4379-RD5113160	75R81472	RD-5-11316-0P
RDHRD5113220P	4379-RD5113220	75R81482	RD-5-11322-0P
RDHRD5113260P	4379-RD5113260	75R81502	RD-5-11326-0P
RDHRD5113280P	4379-RD5113280	75R81512	RD-5-11328-0P
RDHRD5113340P	4379-RD5113340	75R81562	RD-5-11334-0P
RDHRD5123320P	4379-RD5123320	75R81632	RD-5-12332-0P
RDHRD5123340P	4379-RD5123340	75R81662	RD-5-12334-0P
8164872	4379-RD575220	75R8422	RD-5-7120-0P
8022507	4379-RD575220	75R8432	RD-5-7522-0P
RDHRD575220P	4379-RD575220	75R8432	RD-5-7522-0P
3916160	4379-RD5102970, 206RD413M	75R84612	RD-5-10297-0P
RDHRD5104950P	4379-RD5104950	75R8742	RD-5-10495-0P
3916657	4379-RD568681	71R8301	RD-5-6868-1P
3919114, 3949396	4379-RD571550	71R8400	RD-5-7155-0P
3949398	4379-RD589360	71R8430	RD-5-8936-0P
RDHRD5107450P	4379-RD5107450	78R5420	RD-5-10745-0P
RDHRD437272P	4379-RD437272	77R6920	RD-4-3727-2P
RDHRD439900P	4379-RD439900	77R6930	RD-4-3990-0P
RDHRD445500P	4379-RD445500	77R6935	RD-4-4550-0P
RDHRD454620P	4379-RD454620	77R6945	RD-4-5462-0P
RDHRD5124880P	4379-RD5124880P	77R6957	RD-5-12488-0P
RDHRD444031P	4379-RD444031	77R6960	RD-4-4403-1P
RDHRD451900P	4379-RD451900	77R6970	RD-4-5190-0P
RDHRD451901P	4379-RD451901	77R6975	RD-4-5190-1P
RDHRD439011P	4379-RD439011	77R6980	RD-4-3901-1P
RDHRD452264P	4379-RD452264	77R8301	RD-4-5226-4P
RDHRD452265P	4379-RD452265	77R8303	RD-4-5226-5P
RDHRD5104340P	4379-RD5104340	74R2001	RD-5-10434-0P
3949310	4379-RD582540	74R3356	RD-5-8254-0P
RDHRD5118620P	4379-RD5118620	71R3577	RD-5-11862-0P
RDHRD5100560P	4379-RD5100560	71R0453	RD-5-10056-0P

Volvo No.	Mack No.	Red Dot Part No.	Factory No.
85101275	4379-RD5103370	73R0412	RD-5-10337-0P
RDHRD56341P	4379-RD556341	73R0922	RD-5-5634-1P
176314	4379-RD554860	75R0202	RD-5-5486-0P
RDHRD70880P	4379-RD570880	75R8382	RD-5-7088-0P
RDHRD123300P	4379-RD512230	75R81622	RD-5-12330-0P

Mack

Description	Alliance No.	OEM No.	ClimaTech No.	International No.
Compressor	ABP N83 304933	206RD413M	LE1035, LE1135	ZGG19370
Condenser	ABP N83 306907	210RD428	N/A	N/A
Control Cable	ABP N83 327376	7787-530244	N/A	N/A
Expansion Valve	ABP N83 308011	4379-RD568680	EA1065	1676649C1
Expansion Valve	ABP N83 308071	4379-RD570150	EA1075	1676665C1
Expansion Valve	ABP N83 308125	7787-869221, 329-488	N/A	N/A
Filter	ABP N83 328135	7787-525784	N/A	N/A
Receiver Drier	ABP N83 319504	088294-01, 02, 221RD335	JA1980	ZGG19145
Receiver Drier	ABP N83 319554	088268-01, 221RD334	JA1975	ZGG19144
Relay (Actuator)	ABP N83 301459	VCC32000022		

Peterbilt

Description	Alliance No.	OEM No.	ClimaTech No.	International No.
Accumulator	ABP N83 319029	849748, 18-03837, JC1080	JC1080	ZGG19786
Blower Motor	ABP N83 301981	P93CAA-0301-01S / HA1825	HA1825	ZGG701017
Blower Motor	ABP N83 301461	203139BSM	203139BSM	N/A
Blower Motor	ABP N83 301001	RD-5-6526-0, HA1070	HA1070	117283C91, ZGG19269, 1676648C1
Compressor	ABP N83 304953	4645	LE1150, F69-6002-243	2003413C91
Compressor	ABP N83 304853	4647, 4713, 18-04088, F69-6001-253	LE1135, LE1620	2032287C91
Compressor	ABP N83 304344	4660	N/A	ZGG705006
Compressor	ABP N83 304973	4667, F69-6002-114, K318-103	LE1085	3579878C1
Compressor	ABP N83 304873	4672, F69-6001-215	N/A	ZGG705009
Compressor	ABP N83 304394	4739, F69-6002-214, 18-04291	F69-6002-214	N/A
Compressor	ABP N83 304481	Sanden #4425, 4792 for Cat 3406 engine	F69-6000, F69-6002-122	N/A
Compressor	ABP N83 304741	Sanden #4432, 4759 for Detroit S60 series engine	F69-1003, F69-6002-111	N/A
Compressor	ABP N83 304019	488-25011, 18-03536	LE1000	1691725-C92
Compressor	ABP N83 304222	9285	LE1015	ZGG11065
Compressor	ABP N83 304125	4627	LE1145	ZGG19296
Compressor	ABP N83 304163	4731, F69-6001-121, 122	F69-6001-121,122	N/A
Compressor	ABP N83 304173	4484, 18-04373	F69-6002-233	N/A
Compressor	ABP N83 304095	F69-1002, F69-6001-153, F69-6002-133	LE1140	ZGG19316
Compressor	ABP N83 304333	4665, 18-03788	LE1150	ZGG19297
Compressor	ABP N83 304363	18-03787, 4639SAN	LE1035	ZGG19370
Compressor	ABP N83 304363	18-04088, 4713SAN	LE1620	ZGG705007
Compressor	ABP N83 304659	4696, 18-04154, F69-1000	F69-1000	ZGG705129
Condenser	ABP N83 306420	18-03809	18-03809	N/A
Condenser	ABP N83 306907	210RD428	210RD428	N/A
Condenser	ABP N83 306120	PA1200	PA1200	N/A
Expansion Valve	ABP N83 308011	RD-5-6868-0, EA1065	EA1065	1676649C1
Expansion Valve	ABP N83 308141	540057BSM	EA1310	1699955C1
Orifice Tube	ABP N83 308017	P93CAB2500-01S, EC1015	EC1015	ZGG16244
Receiver Drier	ABP N83 319514	402529 / JA1085	JA1085	1676653C1
Receiver Drier	ABP N83 319574	F37-6000	F37-6000	ZGG7102051
Receiver Drier	ABP N83 319110	18-01800 / JA1240	JA1240	1676663C1
Relay (Actuator)	ABP N83 301459	VCC32000022		

HIGH VOLUME PARTS

APPLICATIONS

Volvo No.	Mack No.	Red Dot Part No.	Factory No.
3916160	4379-RD5102970, 206RD413M	75R84612	RD-5-10297-0P
RDHRD464150P	4379-RD464150	77R7717	RD-4-6415-0P
RDHRD5105880P	4379-RD5105880	72R8180	RD-5-10588-0P
3916657	4379-RD568681	71R8301	RD-5-6868-1P
RDHRD70150P	4379-RD570150	71R8321	RD-5-7015-1P
RDHRD5105460P	4379-RD5105460, 7787-869221	71R8385	RD-5-10546-0P
RDHRD5105930P	4379-RD5105930, 7787-525784	78R5235	RD-5-10593-0P
3949131	4379-RD-582410, 221RD335	74R3076	RD-5-8241-0P
176240	4379-RD-567681, 221RD334	74R3322	RD-5-6768-1P
RDHRD5118620P	4379-RD5118620	71R3577	RD-5-11862-0P

Volvo No.	Mack No.	Red Dot Part No.	Factory No.
176565	4379-RD549610	74R5050	RD-5-4961-0P
3949265	4379-RD5103360	73R0042	RD-5-10336-0P
RDHRD582120P	4379-RD582120	73R0222	RD-5-8212-0P
3949262	4379-RD565260	73R0422	RD-5-6526-0P
RDHRD5113130P	4379-RD5113130	75R81452	RD-5-11313-0P
RDHRD5113160P	4379-RD5113160	75R81472	RD-5-11316-0P
RDHRD5113220P	4379-RD5113220	75R81482	RD-5-11322-0P
RDHRD5113260P	4379-RD5113260	75R81502	RD-5-11326-0P
RDHRD5113280P	4379-RD5113280	75R81512	RD-5-11328-0P
RDHRD5113340P	4379-RD5113340	75R81562	RD-5-11334-0P
RDHRD5123320P	4379-RD5123320	75R81632	RD-5-12332-0P
RDHRD5123340P	4379-RD5123340	75R81662	RD-5-12334-0P
3918277	4379-RD558760	75R8512	RD-5-5876-0P
3916160	4379-RD555750	75R8292	RD-5-5575-0P
8164872	4379-RD571200	75R8422	RD-5-7120-0P
RDHRD5102730P	4379-RD5102730	75R84292	RD-5-10273-0P
RDHRD5102740P	4379-RD5102740	75R84312	RD-5-10274-0P
8022507	4379-RD575220	75R8432	RD-5-7522-0P
85100887	4379-RD5102950	75R84572	RD-5-10295-0P
3916160	4379-RD5102970, 206RD413M	75R84612	RD-5-10297-0P
RDHRD5102970P	4379-RD5102970, 206RD413M	75R84612	RD-5-10297-0P
RDHRD5104950P	4379-RD5104950	75R8742	RD-5-10495-0P
RDHRD456580P	4379-RD456580	77R6950	RD-4-5658-0P
RDHRD464150P	4379-RD464150	77R7717	RD-4-6415-0P
RDHRD436832P	4379-RD436832	77R7900	RD-4-3683-2P
3916657	4379-RD568681	71R8301	RD-5-6868-1P
3949398	4379-RD589360	71R8430	RD-5-8936-0P
3093407	4379-RD590820	71R8505	RD-5-9082-0P
61510-001	4379-RD535930	74R1756	RD-5-3593-0P
RDHRD5104340P	4379-RD5104340	74R2001	RD-5-10434-0P
RDHRD549550P	4379-RD549550	74R2706	RD-5-4955-0P
RDHRD5118620P	4379-RD5118620	71R3577	RD-5-11862-0P

Thomas Built

Description	Alliance No.	OEM No.	ClimaTech No.	International No.
Air Filter	ABP N83 328194	8566-0439, 97032815	N/A	ZGG720002
Air Filter	ABP N83 328223	8566-0237, 96932823	N/A	N/A
Air Filter	ABP N83 328204	96932818	N/A	N/A
Air Filter	ABP N83 328214	8566-0237, 96932821	N/A	ZGG720006
Air Filter	ABP N83 328213	96932820	N/A	N/A
Blower Motor	ABP N83 301921	8566-0226	N/A	2503277C1
Blower Motor	ABP N83 301161	8566-0130, 73069008	HA1005	411876C1
Blower Motor	ABP N83 301901	2807-406-109	N/A	N/A
Blower Motor	ABP N83 301881	8566-0378	N/A	2503279C1
Blower Motor	ABP N83 301871	6500-0439, 8566-0378	N/A	ZGG11643, ZGG19343
Blower Motor	ABP N83 301911	4316246	N/A	ZGG701089
Defrost Fan	ABP N83 309141	5200-3268	N/A	221099C1, 4507329R1
Defrost Fan	ABP N83 309311	783966C93	N/A	783966C93

Volvo

Description	Alliance No.	OEM No.	ClimaTech No.	International No.
APADS Press. Switch	ABP N83 318828	3966805, 8040161P	N/A	N/A
APADS Press. Switch	ABP N83 318138	8040202	N/A	N/A
APADS Press. Switch	ABP N83 318848	3939317, 8040147P	N/A	1699309C1
APADS Press. Switch	ABP N83 318868	3948747	N/A	N/A
APADS Press. Switch	ABP N83 318888	3948749	N/A	N/A
APADS Press. Switch	ABP N83 318658	20357742	N/A	N/A
APADS Press. Switch	ABP N83 318668	20357741	N/A	N/A
APADS Press. Switch	ABP N83 318678	3939313	N/A	N/A
APADS Press. Switch	ABP N83 318610	3939314, 8042106P	N/A	N/A
Blower Motor	ABP N83 301307	BOA 85 440 50 009, 176140, 3949102	HB1880	ZGG19230
Blower Motor Kit	ABP N83 301362	3945237	HB1660	ZGG13501, ZGG701071
Compressor	ABP N83 304624	4494, 8088112, 20501069	N/A	ZGG705257
Compressor	ABP N83 304344	4660, 8177089	N/A	ZGG705006
Compressor	ABP N83 304524	4699, 20501069, 8080059, 8088112	N/A	N/A
Compressor	ABP N83 304594	4780, 20370292	N/A	N/A
Compressor	ABP N83 304574	4777, 20370289	N/A	N/A
Compressor	ABP N83 304654	4894, 85104467	N/A	N/A
Compressor	ABP N83 304674	4896, 85104468	N/A	N/A
Compressor	ABP N83 304684	5424	N/A	N/A
Compressor	ABP N83 304534	4490, 4716, 8082268	N/A	N/A
Compressor	ABP N83 304125	4627, 20370291, 8164872	LE1145	ZGG19296
Compressor	ABP N83 304095	4626, 4695, 8022507	LE1140	ZGG19316
Compressor	ABP N83 304213	4715, 8082269, 85104593	N/A	N/A
Compressor	ABP N83 304243	4778, 20370290	N/A	N/A
Expansion Valve	ABP N83 308011	3916657	EA1065	1676649C1
Expansion Valve	ABP N83 308009	BOA-80-321-00-169 / 3949281	EA1365	ZGG19226
Receiver Drier	ABP N83 319660	088366-00, 20407205, 8078261	JA2080	N/A
Receiver Drier	ABP N83 319258	088485-01, 20447319	N/A	N/A
Receiver Drier	ABP N83 319394	3934718 / 61510-0008	JA1280	ZGG19150
Receiver Drier	ABP N83 319910	3949280, 8086753	JA1325, JA1960	1693117C1

HIGH VOLUME PARTS

APPLICATIONS

Volvo No.	Mack No.	Red Dot Part No.	Factory No.
RDHRD5100770P	4379-RD5100770	78R5236	RD-5-10077-0P
RDHRD5100760P	4379-RD5100760	78R5244	RD-5-10076-0P
RDHRD5100790P	4379-RD5100790	78R5254	RD-5-10079-0P
RDHRD5100750P	4379-RD5100750	78R5256	RD-5-10075-0P
RDHRD5100740P	4379-RD5100740	78R5258	RD-5-10074-0P
RDHRD5103790P	4379-RD5103790	73R0012	RD-5-10379-0P
RDHRD559090P	4379-RD559090	73R0022	RD-5-5909-0P
RDHRD5100710P	4379-RD5100710	73R0082	RD-5-10071-0P
RDHRD5100700P	4379-RD5100700	73R0142	RD-5-10070-0P
RDHRD5100690P	4379-RD5100690	73R0632	RD-5-10069-0P
RDHRD5100720P	4379-RD5100720	73R0642	RD-5-10072-0P
61103-0024	4379-RD557960	73R9062	RD-5-5796-0P
3916157, RDHRD5104900P	4379-RD5104900	73R9082	RD-5-10490-0P

Volvo No.	Mack No.	Red Dot Part No.	Factory No.
RDHRD5107780P	4379-RD5107780	71R6418	RD-5-10778-0P
RDHRD5104700P	4379-RD5104700	71R6420	RD-5-10470-0P
3939317	4379-RD5107790	71R6422	RD-5-10779-0P
3948747	4379-RD5107840	71R6426	RD-5-10784-0P
3948749	4379-RD5107870	71R6434	RD-5-10787-0P
20357742	4379-RD5108560	71R6568	RD-5-10856-0P
20357741	4379-RD5108570	71R6571	RD-5-10857-0P
3939313	4379-RD5108590	71R6573	RD-5-10859-0P
3939314	4379-RD5108610	71R6578	RD-5-10861-0P
176140, 3949102	4379-RD5114660	73R3002	RD-5-11466-0P
3945237	4379-RD3105380	73R4532	RD-3-10538-0P
20501069	4379-RD112570	75R81372	RD-5-11257-0P
8177089	4379-RD5113220	75R81482	RD-5-11322-0P
8080059, 8088112	4379-RD5113300	75R81532	RD-5-11330-0P
20370292	4379-RD5113370	75R81582	RD-5-11337-0P
20370289	4379-RD5113430	75R81652	RD-5-11343-0P
85104467	4379-RD5113450	75R81672	RD-5-11345-0P
85104468	4379-RD5113470	75R81692	RD-5-11347-0P
RDHRD5113480P	4379-RD5113480	75R81702	RD-5-11348-0P
8082268	4379-RD5113560	75R81762	RD-5-11356-0P
20370291, 8164872	4379-RD571200	75R8422	RD-5-7120-0P
8022507	4379-RD575220	75R8432	RD-5-7522-0P
8082269, 85104593	4379-RD5102780	75R84382	RD-5-10278-0P
20370290	4379-RD5102810	75R84432	RD-5-10281-0P
3916657	4379-RD568681	71R8301	RD-5-6868-1P
3949281	4379-RD575670	71R8370	RD-5-7567-0P
RDHRD5107420P	4379-RD5107420	74R1406	RD-5-10742-0P
20447319	4379-RD5107430	74R1426	RD-5-10743-0P
3934718, 20407203	4379-RD597890	74R3106	RD-5-9789-0P
3949280, 8086753	4379-RD549590	74R3450	RD-5-4959-0P

QUICK REFERENCE

Volvo

Description	Alliance No.	OEM No.	ClimaTech No.	International No.
Resistor	ABP N83 321300	3949112	CA1035	1696836C1
Water Valve	ABP N83 324145	1118413	MA1110	ZGG717007

Western Star

Description	Alliance No.	OEM No.	ClimaTech No.	International No.
Blower Motor-Main	ABP N83 301771	RD-3-8657-0		
Blower Motor-Sleeper	ABP N83 301001	60009-5003, 5009	HA1070, HA1780	117283-C91
Compressor	ABP N83 304095	61104-3420	LE1140	ZGG19316
Expansion Valve	ABP N83 308011	60012-5001	EA1065	1676649-C1
Pressure Switch (Trinary)	ABP N83 322200	RD-5-4625-0		
Receiver Drier	ABP N83 319048	61506-3404, 088321-00	JA1890	
Receiver Drier	ABP N83 319314	61506-3406		
Thermostat	ABP N83 323010	60054-4421	BD1105	1691722C91

All Makes Products

Description	Alliance No.	OEM No.	ClimaTech No.	International No.
Defrost Fan	ABP N83 309015	783966C93	N/A	783966C93
Electrical Connector Kit	ABP N83 322842		N/A	N/A
Filter, Hi Efficiency Gideon	N/A	FEFF003	N/A	N/A
Filter, Hi Efficiency Gideon	N/A	FEFF004	N/A	N/A
Filter, RESPA Gideon Precleaner	N/A	N/A	N/A	N/A
Filter, RESPA Gideon Precleaner	N/A	N/A	N/A	N/A
Filter, Gideon Precleaner	N/A	N/A	N/A	N/A
Filter, Gideon Precleaner	N/A	N/A	N/A	N/A
Flush 1 GAL.	ABP N83 326025		VA1070	ZGG725011
#6 Goodyear Hose 50ft	ABP N83 313106	D1037-3023	AA1045	ZGG16971
#6 Parker P80 Hose 100ft	ABP N83 313120	P80-6	N/A	N/A
#8 Goodyear Hose 50ft	ABP N83 313118	D1037-3037	N/A	ZGG16972
#8 Parker P80 Hose 100ft	ABP N83 313125	P80-8	N/A	N/A
#10 Goodyear Hose 50ft	ABP N83 313100	D1037-3058	AA1055	ZGG16973
#10 Parker P80 Hose 100ft	ABP N83 313130	P80-10	N/A	N/A
#12 Goodyear Hose 50ft	ABP N83 313102	D1037-3064	D1037-3064	ZGG16974
#12 Parker P80 Hose 100ft	ABP N83 313135	P80-12	N/A	N/A
Per-Job O-Ring Kit	ABP N83 312125		VH1160	ZGG12033, 12034, 19129
Slimline Seal, #6, 9/16" O.D. x 5/16" I.D.	ABP N83 312076			
Slimline Seal, #8, 1 1/16" O.D. x 7/16" I.D.	ABP N83 312060			
Slimline Seal, #10, 3/4" O.D. x 9/16" I.D.	ABP N83 312092			
Mini Stat-O-Seal, #6, 5/8" O.D. x 5/16" I.D.	ABP N83 312366	336565, 23-13201-000		
Mini Stat-O-Seal, #8, 3/4" O.D. x 7/16" I.D.	ABP N83 312368	556565, 23-13202-000		
Mini Stat-O-Seal, #10, 1 1/16" O.D. x 9/16" I.D.	ABP N83 312361	668565, 23-13203-000		
Mini Stat-O-Seal, #12, 1 1/8" O.D. x 1 1/16" I.D.	ABP N83 312372	720565, 23-13205-000		
Slimline Seal, 17mm, 1" O.D. x 5/8" I.D.	ABP N83 312222	23-13204-000		
Retro Fit Kit - CCI/Tecumseh	ABP N83 325010		VC2000	ZGGH550432
Retro Fit Kit - GM	ABP N83 325513		VC2015	ZGGH725016
Retro Fit Kit - Sanden/Seltec	ABP N83 325511		VC2005	ZGGH550433
Sanden PAG Oil	ABP N83 326013		LM1035	NA

HIGH VOLUME PARTS

Volvo No.	Mack No.	Red Dot Part No.	Factory No.
3949112	4379-RD5103410	71R1457	RD-5-10341-0P
1118413	4379-RD5103450	72R6530	RD-5-10345-0P

Volvo No.	Mack No.	Red Dot Part No.	Factory No.
RDHRD386570P	4379-RD386570	73R1002	RD-3-8657-0P
60009-5003, 5009, 176121	4379-RD565260	73R0422	RD-5-6526-0P
8022507	4379-RD575220	75R8432	RD-5-7522-0P
3916657	4379-RD568680	71R8300	RD-5-6868-0P
RDHRD546250P	4379-RD546250	71R7650	RD-5-4625-0P
RDHRD575170P	4379-RD575170	74R3136	RD-5-7517-0P
176248	4379-RD575171	74R3376	RD-5-7517-1P
RDHRD5453124P	4379-RD5453124	71R3200	RD-5-4531-24P

Volvo No.	Mack No.	Red Dot Part No.	Factory No.
3916157, RDHRD5104900P	4379-RD5104900	73R9082	RD-5-10490-0P
RDHRD5119660P	4379-RD5119660	79R3532	RD-5-11966-0P
RDHRD5125330P	4379-RD5125330	78R5260	RD-5-12533-0P
RDHRD5125340P	4379-RD5125340	78R5261	RD-5-12534-0P
RDHRD5125310P	4379-RD5125310	78R5622	RD-5-12531-0P
RDHRD5125320P	4379RD5125320	78R5624	RD-5-12532-0P
RDHRD5118590P	4379-RD5118590	78R5632	RD-5-11859-0P
RDHRD5118600P	4379-RD5118600	78R5634	RD-5-11860-0P
RDHRD5102060P	4379-RD5102060	79R4650	RD-5-10206-0P
3949322	4379-RD55006600	78R0456	RD-5-5006-600P
176556	4379-RD598200	78R8806	RD-5-9820-0P
3949323	4379-RD55008600	78R0458	RD-5-5008-600P
176555	4379-RD598210	78R8808	RD-5-9821-0P
3949324	4379-RD55010600	78R0451	RD-5-5010-600P
176558	4379-RD598220	78R8810	RD-5-9822-0P
3949325	4379-RD55012600	78R0452	RD-5-5012-600P
176557	4379-RD598230	78R8812	RD-5-9823-0P
176566, 3949461	4379-RD599870	70R5020	RD-5-9987-0P
RDHRD5102000M	4379-RD5102000	70R5022	RD-5-10200-0M
RDHRD5101990M	4379-RD5101990	70R5024	RD-5-10199-0M
RDHRD5101980M	4379-RD5101980	70R5026	RD-5-10198-0M
RDHRD5115270M	4379-RD5115270	70R5031	RD-5-11527-0M
RDHRD5115280M	4379-RD5115280	70R5032	RD-5-11528-0M
RDHRD5115290M	4379-RD5115290	70R5033	RD-5-11529-0M
RDHRD5115300M	4379-RD5115300	70R5034	RD-5-11530-0M
RDHRD5126750M	4379-RD5126750	70R5035	RD-5-12675-0M
3949456	4379-RD589580	79R4600	RD-5-8958-0P
176377, 3949459	4379-RD589610	79R4615	RD-5-8961-0P
3949457, 8	4379-RD589600	79R4605	RD-5-8960-0P
RDHRD571030P	4379-RD571030	79R4580	RD-5-7103-0P

QUICK REFERENCE

All Makes Products

Description	Alliance No.	OEM No.	ClimaTech No.	International No.
Seltec PAG Oil	ABP N83 326056		LM1070	ZGGR6822
Slim Line/Stat-O-Seal Service Kit	ABP N83 322860	NA	NA	NA

EZ Clip Fittings

Description	Alliance No.	OEM No.	ClimaTech No.	International No.
Quick Disconnect, #8 male to #6 quick disconnect	ABP N83 311454	NA	NA	NA
Quick Disconnect, #12 male to #10 quick disconnect	ABP N83 311464	NA	NA	NA
Straight Splicer with R-12 Charge Port - #10	ABP N83 311220	FF14232	NA	NA
Straight Splicer with R-12 Charge Port - #12	ABP N83 311932	FF14233	NA	NA
Straight Splicer with R-12 Charge Port - #6	ABP N83 311936	FF14230	NA	NA
Straight Splicer with R-12 Charge Port - #8	ABP N83 311938	FF14231	NA	NA
90° Bulkhead - #10	ABP N83 311941	FF14222	NA	NA
90° Bulkhead - #6	ABP N83 311946	FF14220	NA	NA
90° Bulkhead - #8	ABP N83 311948	FF14221	NA	NA
Straight Female O-ring with Low side charge port # 10	ABP N83 311951	FF14224	NA	NA
Straight Female O-ring with High side charge port #8	ABP N83 311958	FF14226	NA	NA
90° Splicer - #10	ABP N83 311961	FF14240	NA	NA
90° Splicer - #6	ABP N83 311966	FF14238	NA	NA
90° Splicer - #8	ABP N83 311968	FF14239	NA	NA
Straight Male O-ring with High side charge port - # 8	ABP N83 311978	FF14235	NA	NA
45° Male o-ring - #10	ABP N83 311971	FF14216	NA	NA
45° Male o-ring - #6	ABP N83 311976	FF14215	NA	NA
45° Male o-ring - #8	ABP N83 311988	FF14214	NA	NA
90° Male O-ring with High side charge port - #8	ABP N83 311998	FF14236	NA	NA
O-Ring - FNBR #6	ABP N83 312346	-	NA	NA
O-Ring - FNBR #8	ABP N83 312348	-	NA	NA
O-Ring - FNBR #10	ABP N83 312340	-	NA	NA
O-Ring - FNBR #12	ABP N83 312342	-	NA	NA
90° Bulkhead - #10 to #12	ABP N83 310360	FF14223	NA	NA
90° Male O-ring with Low side charge port - #10 to #12	ABP N83 310320	FF14237	NA	NA
Straight Female O-ring with Low side charge port # 10 to #12	ABP N83 310300	FF14225	NA	NA
Straight Male O-ring with Low side charge port - # 10 to #12	ABP N83 310310	FF14234	NA	NA
Straight Bulkhead Fitting - #10	ABP N83 310340	FF14219	NA	NA
90° Female O-ring with 7/16" Switch Port - #10 to #12	ABP N83 310350	FF14229	NA	NA
Straight Bulkhead Fitting - #6	ABP N83 310346	FF14217	NA	NA
Straight Bulkhead Fitting - #8	ABP N83 310348	FF14218	NA	NA
90° Female O-ring with 7/16" Switch Port - #6	ABP N83 310356	FF14227	NA	NA
90° Female O-ring with 7/16" Switch Port - #8	ABP N83 310358	FF14228	NA	NA
EZ CLIP TOOL KIT	ABP N83 327980	FF12139	NA	NA
#6 EZ Clip Hose	ABP N83 313406	-	NA	NA
#8 EZ Clip Hose	ABP N83 313408	-	NA	NA
#10 EZ Clip Hose	ABP N83 313401	-	NA	NA
#12 EZ Clip Hose	ABP N83 313402	-	NA	NA

HIGH VOLUME PARTS

Volvo No.	Mack No.	Red Dot Part No.	Factory No.
RDHRD571660P	4379-RD571660	79R4585	RD-5-7166-0P
RDHRD5126760P	4379-RD5126760	79R8950	RD-5-12676-0P

Volvo No.	Mack No.	Red Dot Part No.	Factory No.
RDHRD248441P	4379-RD248441	70R3908	RD-2-4844-1P
RDHRD248451P	4379-RD248451	70R3912	RD-2-4845-1P
RDHRD5105721P	4379-RD5105721	70R8061	RD-5-10572-1P
RDHRD5105731P	4379-RD5105731	70R8062	RD-5-10573-1P
RDHRD5105701P	4379-RD5105701	70R8066	RD-5-10570-1P
RDHRD5105711P	4379-RD5105711	70R8068	RD-5-10571-1P
RDHRD5105621P	4379-RD5105621	70R8071	RD-5-10562-1P
RDHRD5105601P	4379-RD5105601	70R8086	RD-5-10560-1P
RDHRD5105611P	4379-RD5105611	70R8088	RD-5-10561-1P
RDHRD5105641P	4379-RD5105641	70R8201	RD-5-10564-1P
RDHRD5105661P	4379-RD5105661	70R8208	RD-5-10566-1P
RDHRD5105801P	4379-RD5105801	70R8291	RD-5-10580-1P
RDHRD5105781P	4379-RD5105781	70R8296	RD-5-10578-1P
RDHRD5105791P	4379-RD5105791	70R8298	RD-5-10579-1P
RDHRD5105751P	4379-RD5105751	70R8688	RD-5-10575-1P
RDHRD5105561P	4379-RD5105561	70R8341	RD-5-10556-1P
RDHRD5105551P	4379-RD5105551	70R8346	RD-5-10555-1P
RDHRD5105541P	4379-RD5105541	70R8348	RD-5-10554-1P
RDHRD5105761P	4379-RD5105761	70R8398	RD-5-10576-1P
RDHRD5110150M	4379-RD5110150	70R8506	RD-5-11015-0M
RDHRD5110160M	4379-RD5110160	70R8508	RD-5-11016-0M
RDHRD5110170M	4379-RD5110170	70R8510	RD-5-11017-0M
RDHRD5110180M	4379-RD5110180	70R8512	RD-5-11018-0M
RDHRD5105631P	4379-RD5105631	70R8591	RD-5-10563-1P
RDHRD5105771P	4379-RD5105771	70R8598	RD-5-10577-1P
RDHRD5105651P	4379-RD5105651	70R8621	RD-5-10565-1P
RDHRD5105741P	4379-RD5105741	70R8681	RD-5-10574-1P
RDHRD5105591P	4379-RD5105591	70R8881	RD-5-10559-1P
RDHRD5105691P	4379-RD5105691	70R8891	RD-5-10569-1P
RDHRD5105571P	4379-RD5105571	70R8886	RD-5-10557-1P
RDHRD5105581P	4379-RD5105581	70R8888	RD-5-10558-1P
RDHRD5105671P	4379-RD5105671	70R8996	RD-5-10567-1P
RDHRD5105681P	4379-RD5105681	70R8998	RD-5-10568-1P
85100261	4379-RD5107180	79R8915	RD-5-10718-0P
85100278	4379-RD510504600	78R8456	RD-5-10504-600P
RDHRD510505600P	4379-RD510505600	78R8458	RD-5-10505-600P
RDHRD510506600P	4379-RD510506600	78R8451	RD-5-10506-600P
RDHRD510507600P	4379-RD510507600	78R8452	RD-5-10507-600P

APPLICATIONS

MODEL	YEAR	DESCRIPTION	OEM P/N	ALLIANCE P/N
CARRIER				
BLOWER MOTOR				
Bus Parts		Blower motor	BLW-200-41	ABP N83 301048
BLOWER WHEEL				
Bus Parts		Blower Wheel	MCC# 38-00564-50	ABP N83 302008
FAN				
Bus Parts		Vector fan	MTR-140V	ABP N83 301163
Bus Parts		Condenser fan	MTR-105P	ABP N83 301164
RECEIVER DRIER				
Bus Parts		Receiver Drier	DRI-104	ABP N83 319013
CHEVROLET/GMC				
ACTUATOR				
Topkick	1992-01	Electric, Rotary, Duct Door	16141802	ABP N83 301419
COMPRESSOR				
Topkick	1993	Sanden 7H15, 12V, 2A Groove, 125MM, 2 Wire, QD Head	12387671 15679484	ABP N83 304652
Topkick	1980-85	GM A6, 1 groove ½" width, 4 ⅞" diameter (124mm), generic	1131202 12300270 1131197	ABP N83 304008
Topkick	1994-00	Sanden 7H15, 12V, 2A Groove, 125MM, 2 Wire, QD Head	15653237 15680077 15020478	ABP N83 304652
EXPANSION VALVE				
Topkick	1978-92	Block, #6 #10 #8 #8, with Mounting Holes	02-7086617	ABP N83 308011
Topkick	1991-00	Orifice Tube-Blk/Wht	3093576 3096068	ABP N83 308037
ORIFICE TUBE				
Topkick	1999-10	Orifice Tube-White	15-5151 3033879 3033919	ABP N83 308049
RECEIVER DRIER				
Topkick	1980-93	In-line Drier, 2 ½" x 6 ⅞", #6 to #8 male O-Ring	15-1641 15505227 2724475 3949269	ABP N83 319100
RELAY				
Topkick	1983-85	Relay, Blower, 12V, 20A/30A, Tab Mount, 5 Terminals	2098912	APB N83 320140
Topkick	1985-93	Relay, Blower, 12V, 20A/30A, Tab Mount, 5 Terminals	221655	APB N83 320140
Topkick	1990-2000	Relay, Blower, 12V, 30A/40A, Socket Mount	14100455 25520198 3949297	APB N83 320140
Topkick	1990-95	Relay, Blower, 12V, 30A/40A, Socket Mount	14100455 3949297	APB N83 320140
WATER VALVE				
Topkick	1984-89	Cable Controlled, ⅝" Hose, STR-STR, Pull to Open	3857131	ABP N83 324050

APPLICATIONS

MODEL	YEAR	DESCRIPTION	OEM P/N	ALLIANCE P/N
FREIGHTLINER				
ACTUATOR				
All		Single action air cylinder, 3/4" diameter, 3 1/4" length	RDH RD3267 1	ABP N83 318183
M2	2002-07	Universal, 1 1/2" V, 4 pin Deutz Connector, 104° Max Travel	VCC32000022	ABP N83 301458
BLOWER MOTOR				
All	1998-00	A/C and heater 7 7/8" flange motor, CW, vented, shaft length 1 1/2"	ABP N83 301020	ABP N83 301020
All	2000-06	Behr Auxillary Unit (with water valve), plate mount, 7 3/16" diameter	ABP N83 301327 2809-841-036	ABP N83 301327
All	2002-06	Auxillary Unit (front with blend air), plate mounted 7" diameter, CCW	BOA 85-462-50-009 2809-841-036	ABP N83 301891
Century C112, Century C120, Columbia	1994 -01	Main unit (Assembly), plate mounted, 7" diameter, CW, 1 speed, 4 3/4" length	ABP N83 301137 BOA-85-440-50-009 HA1870	ABP N83 301137
Century C112, Century C120, Columbia	1994-04	Main unit (Assembly), plate mount, 7 3/16" diameter	BOA-80-415-00-789	ABP N83 301317
Century C112, Century C120, Columbia	2002-05	Main unit with blower assembly, plate mount, 7 3/16" diameter	BOA-85-462-5000-900 2809-850-053	ABP N83 301327
Century C112, Century C120, Columbia, Coronado	2002-11	Front and Aux with Blend air system	BOA94350 BOAD8587	ABP N83 301303
Classic XL, FLD Conventional	2006-07	Sleeper cab motor, single shaft with brackets	2808-841-036M	ABP N83 301043
FL50, FL60, FL70, FL80, FL106, FL112	1994-01	Main unit (Assembly), plate mount, 7" diameter		ABP N83 301891
FL50, FL60, FL70, FLB, FLL	1994-04	Main unit (Assembly), plate mounted, 7" diameter, CW, 1 speed, 4 3/4" length	BOA-85-440-50-009	ABP N83 301307
FLD112, FLD120, Coronado	2002-10	Auxillary Unit (water valve control), single shaft, plate mount, 7" diameter	BOA-85-462-50-009	ABP N83 301891
CLUTCH ASSEMBLY				
All		2 groove 6" diameter pulley, 1/2" width, 1 5/8" ga, bullet plug	03-1104973 501215 518521	ABP N83 303252
All		1 groove, 6 3/4" diameter pulley, 1/2" width, 1 3/4" gaugeline, bullet plug	A22-22499 L50-2731 ABP N83 303071	ABP N83 303071
All		Poly 6 groove, 4.7" 119mm diameter pulley, bullet plug	6524-6010	ABP N83 303197
All		Poly 8 groove, 4.9" 125mm dia groove	6593-6010	ABP N83 303157
All		2 groove 5 23/64" 135mm diameter pulley, 1/2" width, bullet plug	2570151 624-19724	ABP N83 303712
All		2 groove 7" diameter pulley, 24V, 1/2" width, 2" ga, bullet plug	ABP N83 303342 501075	ABP N83 303342
All		12V, 2A Groove, 132MM, 1 Wire	6514-6210 6519-6010 6575-6310	ABP N83 303282
All		12V, 2A Groove, 125MM, 2 Wire	4740-9931 6593-6010	ABP N83 303402
All		12V, 1A Groove-Overhang, 125MM, 1 Wire	511869 ABP N83 303261	ABP N83 303261
All		12V, PV6 Groove, 5 3/4", 2 Wire	024 25244	ABP N83 303277
All		12V, PV6 Groove, 5 3/4", 1 Wire	024 25144 ABP N83 303287	ABP N83 303287

APPLICATIONS

MODEL	YEAR	DESCRIPTION	OEM P/N	ALLIANCE P/N
FREIGHTLINER				
CLUTCH ASSEMBLY				
All		12V, PV6 Groove, 5 7/8", 2 Wire	024 25241 MAE MG07 ABP N83 303187	ABP N83 303187
All		12V, PV6 Groove, 6 1/8", 1 Wire	024 25078 ABP N83 303007 513352	ABP N83 303007
All		12V, PV8 Groove, 5 3/8", 1 Wire	ABP N83 303307 ABP N83 303017	ABP N83 303307
All		12V, PV8 Groove, 6 1/8", 2 Wire	024 25247 ABP N83 303123T	ABP N83 303123T
All		12V, 2A Groove, 6", 1 Wire	024 25190 03-1104973 501939	ABP N83 303082
All		12V, 2A Groove, 6", 2 Wire	024 25238 ABP N83 303063T	ABP N83 303063T
All		12V, 2A Groove, 7", 1 Wire	ABP N83 303012 332334 MA 7A	ABP N83 303012
All		12V, 1A Groove, 6", 1 Wire	024 21942 ABP N83 303051	ABP N83 303051
COMPRESSOR				
All		7H15, KG head, ear mount, 2A groove, 4.9"(125mm) diameter	4709 22-59343-000	ABP N83 304883
All		7H15, KCA head, direct Mount, 2 groove, 5 1/4" (132mm) diameter	4428 ABP N83 304503	ABP N83 304503
All		7H15, GH head, ear mount, 2 groove, 5 1/4"(132mm) diameter	4429 ABP N83 304803	ABP N83 304803
All		7H15, GH head, direct mount, poly 6 4.9"(125mm) diameter	4430 ABP N38 304813	ABP N38 304813
All		7H15, MJA head, ear mount, poly 8 groove, 4.7"(119mm) diameter	4431 22-47692-000	ABP N83 304823
All		7H15, GV head, ear mount, poly 8 groove 4.7"(119mm) diameter	22-59342-000	ABP N83 304833
All		7H15, MJA head, ear mount, 2 groove, 5 1/4"(132mm) diameter	4471 22-47691-000	ABP N83 304073
All		7H15, CBA head, direct mt, poly 6, 4.9"(125mm) diameter	4475 22-47693-000	ABP N83 304103
All		7H15, GH head, direct mt, poly 6, 4.7"(119mm) diameter	4485 ABP N83 304903	ABP N83 304783
All		7H15, JDA head, ear mt, 2 groove, 5 1/4"(132mm) diameter	4488 22-47690-000	ABP N83 304083
All		7H15, JD head, direct mt, 2 groove, 5 1/4"(132mm) diameter	4491 22-47694-000	ABP N83 304093
All		7H15, MDA head, direct mt, poly 6, 4.9"(125mm) diameter	4492 22-48437-000	ABP N83 304893
All		7H15HD, 12V, 2A Groove, 132MM, 2 Wire, JDA Head, Direct Mount	4626 ABP N83 304095	ABP N83 304095
All		7H15, JD head, ear mt, 2 groove, 5 1/4"(132mm) diameter	4644 ABP N83 304363	ABP N83 304102
All		7H15, MJA head, ear mount, 2 groove, 5 1/4"(132mm) diameter	4646 22-41180-000	ABP N83 304843
All		QP15HD, 12V, 1A Groove Overhang, 125MM, 1 Wire, D Head	488-45063 ABP N83 304039	ABP N83 304039

MODEL	YEAR	DESCRIPTION	OEM P/N	ALLIANCE P/N
FREIGHTLINER				
COMPRESSOR				
All		QP15HD, 12V, 2A Groove, 135MM, 1 Wire, D Head	488-45011 ABP N83 304025	ABP N83 304025
All		QP15HD, 12V, 1 VAR Groove, 159MM, 1 Wire, D Head	488-45065 ABP N83 304015	ABP N83 304015
All		QP15HD, 12V, 1A Groove Overhang, 125MM, 1 Wire, F Head, R-12	488-25063 ABP N83 304029	ABP N83 304029
All		QP15HD, 12V, 2A Groove, 135MM, 1 Wire, F Head, R-12	488-25011 ABP N83 304019	ABP N83 304019
All		Rotolock, LH Suction, #8 Discharge, #10 Suction, NO CLUTCH	ER210L-25149	ABP N83 304171
All		Tube-O, LH Suction, 1"-14 Discharge, 1"-14 Suction, NO CLUTCH	ET210L-25150	ABP N83 304031
All		QP15HD, 12V, 2A Groove, 135MM, 1 Wire, D Head	488-45077 ABP N83 304059	ABP N83 304059
All		w/8 groove 119mm, direct mt, PK head	SK4314	ABP N83 304036Q
All		FLX replacement, 2 groove, 5 ¼"(132mm) diameter	9285	ABP N83 304234
All		7H15, 12V, PV8 Groove, 119MM, 1 Wire, MDA Head	4672 22-43374-000	ABP N83 304873
All		7H15HD, 12V, PV6 Groove, 125MM, 1 Wire, CBA Head, Direct Mount	4687 22-44462-000	ABP N83 304053
All		7H15HD, 12V, PV8 Groove, 119MM, 2 Wire, MDA Head	4734 22-47692-000	ABP N83 304063
All		7H15, MJA head, ear mount, 2 groove, 5 ¼"(132mm) diameter	4735 22-47691-000	ABP N83 304073
All		7H15, JDA head, ear mt, 2 groove, 5 ¼"(132mm) diameter	4736 22-47690-000	ABP N83 304083
All		7H15, JD head, direct mt, 2 groove, 5 ¼"(132mm) diameter	4752 22-47694-000	ABP N83 304093
All		7H15, CBA head, direct mt, poly 6, 4.9"(125mm) diameter	4756 22-47693-000	ABP N83 304103
All		7H15, MDA head, direct mt, poly 6, 4.9"(125mm) diameter	4761 22-48437-000	ABP N83 304893
All		7H15, MDA head, direct mt, poly 8 groove, 4.7"(119mm) diameter	4776 ABP N83 304113	ABP N83 304113
All		7H15, GH head, ear mount, poly 8 groove 4.7"(119mm) diameter	4820 ABP N83 304913	ABP N83 304913
All		7H15, GH head, ear mount, 2 groove, 5 ¼"(132mm) diameter	4821 ABP N83 304803	ABP N83 304803
All		7H15, MD head, ear mount, poly 8 groove 4.7"(119mm) diameter	7822 ABP N83 304803	ABP N83 304803
All		7H15HD, MD head, ear mount, 2 groove, 5 ¼"(132mm) diameter	4617 ABP N83 304303	ABP N83 304303
All		7H15SHD, GH head, direct mount, poly8, (140mm) diameter	4543 ABP N83 304455	ABP N83 304455
All		MDA head, Direct mount, Poly 8 (119mm) diameter	4808 ABP N83 304456	ABP N83 304456
All		Direct mount, Poly 8 (140mm) diameter	4108 4802	ABP N83 304437
All		MDA head, Direct mount, Poly 8 (130mm) diameter	4885 ABP N83 304457	ABP N83 304457
All	1999-00	Tube-O, LH Suction, 1"-14 Discharge, 1"-14 Suction, 12V, 2A Groove, 6", 2 Wire	ET210L-25246C	ABP N83 304201T

APPLICATIONS

MODEL	YEAR	DESCRIPTION	OEM P/N	ALLIANCE P/N
FREIGHTLINER				
COMPRESSOR				
All	2000-04	709, GH head, direct mt, poly 6, 4.9"(125mm) diameter	4819 ABP N83 304813	ABP N83 304813
All	2000-08	709, GH head, direct mt, poly 8, 4.7"(119mm) diameter	4818 ABP N83 304903	ABP N83 304783
All	2001-03	Slimline head with flange fitting without charge ports with ester oil	ES210L-25334C	ABP N83 304071
All	2006-07	7H15, GH head, direct mount, poly 8 groove, 4.7"(119mm) diameter	4417 ABP N83 304783	ABP N83 304783
All	2011-14	Nippondenso PV8 159mm dia direct mount	10S15C 22-65771-000	ABP N83 304915
M2	2010-14	Nippondenso 12v, 8 groove	10S15C 22-65770-000	ABP N83 304914
CONDENSER				
Cascadia	2008-2011	Multi Flow with slim line fittings 44 ½" x 22"	A22-72249-000 A22-66839-000 A22-66824-000 A22-72459-000	RDH RD4 7131 0
Cascadia	2010-2011	Radiator Mount (Dual block fitting)	A22-67126-000 A22-66825-000 A22-66840-000 A22-72250-000	ABP N83 306033
Century C112, Century C120, Columbia, Coronado	2000-05	Multi Flow with slim line fittings	1E 6068 BHT 92710 BHT 73002	RDH RD4 6527 0
Columbia, Coronado	2006-2009	Radiator Mount	A22-67125-000 A22-66824-000 A22-66839-000 A22-72249-000	ABP N83 306032
FLD, Classic XL, Coronado	2004-10	Radiator mt., tube & fin style with slim line fittings	1E6854 BHT79465	ABP N83 306027
M2	2002-10	Serpentine style	BHT P5631001 BHT E2108	New
WFC, WFT	All	Radiator Mount	RDH RD4 3724 0	ABP N83 306270
EVAPORATOR				
Cascadia	2008-2011	All	VCCT1000898P	ABP N83 308097
FLB, FLL, FL50, FL60, FL70, FL80, FL106, FL112	1994-01	Main unit with Behr evaporator	BOA-80-374-00-439	ABP N83 307020
FLD112, FLD120	1994-04	Evaporator	RDH RD2 1402 0 NA1040	ABP N83 307110
EXPANSION VALVE				
All	1997-02	Block, #6 #10 #8 #10, with Mounting Holes	A22-45432-000 ABP N83 308211	ABP N83 308211
All	1998-01	Main unit	A22-45432-000 BOA 80-321-00-129	ABP N83 308009
Century C112, Century C120	1996-00	Main unit	A22-45432-000	ABP N83 308009
Century C112, Century C120	1996-00	Block, #6 #10 #8 #10, with Mounting Holes	A22-45432-000 ABP N83 308071	ABP N83 308071
Century C112, Century C120	1998-2005	with main system bleed type	329-474	ABP N83 308291
Century C112, Century C120, Century S/T, Columbia, Coronado	2000-08	Auxiliary Unit (Mini Stat O Seal), gold color	BOA-80-321-00-269	ABP N83 308235

MODEL	YEAR	DESCRIPTION	OEM P/N	ALLIANCE P/N
FREIGHTLINER				
EXPANSION VALVE				
Century C112, Century C120, Columbia	2002-2010	Main unit	BOAN9535001	ABP N83 308020
Century C112, Century C120, Columbia, Coronado	2000-06	Main unit, (Slim line seal), gold color	ABP N83 308231	ABP N83 308231
Century C112, Century C120, Columbia, Coronado	2001-07	Main unit, (Stat Seal), Behr valve	BOA 4965	ABP N83 308107
Century C112, Century C120, Columbia, Coronado	2002-07	Auxiliary Unit, (Stat Seal), Behr valve, burgundy color	BOA 93674	ABP N83 308117
Century, Columbia, Coronado	9/2000-6/2002	Auxilliary Unit	BOA-80-321-00-269	ABP N83 308241
Coronado, FLD	2003-10	Block, #6 #12 #8 #8, with Mounting Holes	BOA-80-321-00-129	ABP N83 308375
FL50, FL60, FL70, FL80, FL106, FL112	1994-00	Block, #6 #10 #8 #10, with Mounting Holes	A22-45432-000 ABP N83 308071	ABP N83 308211
FL50, FL60, FL70, FL80, FL106, FL112	2000-02	Main unit, Hi - capacity	A22-45432-001 ABP N83 308070	ABP N83 308125
FL50, FL60, FL70, FL80, FL106, FL112, FLL	1994-00	Block, #6 #12 #8 #8, with Mounting Holes	A06-44004-002	ABP N83 308375
FLD112, FLD120, Classic XL, Coronado	1991-00	Block, #6 #12 #8 #8, with Mounting Holes	BOA-80-321-00-129	ABP N83 308211
FLD112, FLD120, Classic XL, Coronado	2001-07	Main unit, (Stat Seal), Behr valve	BOA A4965	ABP N83 308107
M2	2003-07	Main unit (Mini Stat O Seal)	VCC 88000030	ABP N83 308241
M2	2008-10	Block type	VCCT1001838L	ABP N83 308016
FILTER				
All	2003-10	Sleeper unit	A22-46891-000	ABP N83 328375
C, Century C112, Century C120, F	1997-06	Main unit, 10 ½"x10 ½"x¾" filter	22-44665-000	ABP N83 328345
C, Century C112, Century C120, Columbia, Coronado	2002-07	Main unit, 10 ⅝"x10 ⅝"x1" pleated filter	BOA 91559 FR0202P	ABP N83 328175
Columbia, Coronado, Cascadia	2003-11	Main unit, 10 ⅝"x10 ⅝"x1" pleated filter	BOA 91621	ABP N83 328175
O-RINGS / SEALS				
All		#6 Mini Stat -O - Seal, metal washer with red rubber insert, ⅝" O.D., ⅜" I.D.	23-13201-000	ABP N83 312366
All		#8 Mini Stat -O - Seal, metal washer with red rubber insert, ¾" O.D., ⅞" I.D.	23-13202-000	ABP N83 312368
All		#10 Mini Stat -O - Seal , Red, 1⅜" O.D., ⅞" I.D.	ABP N83 312361	ABP N83 312361
All		#12 Mini Stat -O - Seal , Red, 1" O.D., 1⅜" I.D.	PH720565	ABP N83 312372
All		#12 Mini Stat -O - Seal , Red, 1" O.D., 1⅜" I.D.	ABP N83 312372	ABP N83 312372
All		#6 Slimline seal, metal washer (black), ⅝" O.D., ⅜" I.D.	ABP N83 312076	ABP N83 312076
All		#8 Slimline seal, metal washer (black), 1⅜" O.D., ⅞" I.D.	ABP N83 312060	ABP N83 312060
All		#10 Slimline seal, metal washer (black), ¾" O.D., ⅞" I.D.	ABP N83 312092	ABP N83 312092
PRESSURE SWITCH				

APPLICATIONS

MODEL	YEAR	DESCRIPTION	OEM P/N	ALLIANCE P/N
FREIGHTLINER				
EXPANSION VALVE				
Century, Classic, Coronado, FL	1989-04	Switch, Pressure, Trinary, NC	ABP N83 322175	ABP N83 322175
C, Century, Classic, Coronado, FL, W	1994-03	Dual Function switch, M10 x 1.25 Low: open 455 psi, closed 30psi. High: open 28psi, closed 370	22-43249	ABP N83 318099
C, F	1994-03	Switch, Pressure, Low, NO	085108-00	ABP N83 318014
Century C112, Century C120	1997-04	Switch, Pressure, APADS, High, NC	8040279P 8040135	ABP N83 318718
Century C112, Century C120	1997-04	Switch, Pressure, APADS, Low, NC	3966805 8040136 8040152 8040161P	ABP N83 318748
Century C112, Century C120	1997-07	High Pressure Fan switch with M10 threads	A22-45194-001	ABP N83 318180
Century C112, Century C120	2009-11	Switch, Pressure, High	06-35209-000 BOA91619	ABP N83 318035
FL50, FL60, FL70, FL80, FL106, FL112	1994-03	High pressure switch, normally open	A22-30930-000	ABP N83 322315
FL50, FL60, FL70, FL80, FL106, FL112	1994-03	All with Fujikoki binary sw with M10 threads, 4 term.	A22-43249-000	ABP N83 318179
FL50, FL60, FL70, M2	1974-03	Switch, Pressure, Trinary, NO	RDH RD5 4585 0	ABP N83 318009
FL50, FL60, FL70, M2	1994-03	Switch, Pressure, High, NO	BOA-80-941-00-063	ABP N83 318040
FL50, FL60, FL70, M2	1994-03	Switch, Pressure, Trinary, NO	A06-18015-000	ABP N83 318149
M2, FL50, FL60, FL70	2000-2011	Switch, Pressure	A22-512296-000	ABP N83 318085
RECEIVER DRIER				
All	1995-00	All model series with Red Dot A/C, OE# RD-5-11196-0	ABP N83 319735	ABP N83 319735
Cascadia	2010-2012	4"dia 7" long PAD mount fittings	A22-66700-000 A22-69800-000	ABP N83 319015
Century C112, Century C120	1996-01	Slim-line Stato Seal with side mounting	088502-00	ABP N83 319534
Century C112, Century C120	1996-01	Male & Female O-Ring with HPRV, MI, 2 M10 switch ports	ABP N83 319615	ABP N83 319615
Century C112, Century C120	2000-03	Quick Disconnect, side mt. fittings	ABP N83 319524 319510	ABP N83 319665
Century C112, Century C120, Columbia	1996-03	Male O-Ring with fuse plug, side port, top glass	A22-14425-001	ABP N83 319291
Century S/T	2000-07	Slim-line Stato Seal with side mounting	PH088446-00	ABP N83 319584
Century, Columbia	2000-04	Slim-line Stato Seal with side mounting	PH088538-00	ABP N83 319584
Century, Columbia	2002-11	Slim-Line seal top mt with opposing #6 male O-Ring	PH088518-00	ABP N83 319745
Century, Columbia, M2	2008-2010	4"dia 7" long PAD mount fittings	A22-63992-000 A22-63992-001 A22-72392-000	ABP N83 319755
Century, Columbia, Coronado	2000-03	Quick disconnect	ABP N83 319665	ABP N83 319665
FL50, FL60, FL70, FL80, FL106, FL112	1994-01	Male O-Ring with fuse plug, side port, top glass	A22-14425-002	ABP N83 319291
FLD, Classic XL, Coronado	1999-06	3" dia 10" high with quick siconnect	088336-00	ABP N83 319625
FLD112, FLD120, Classic XL	1994-01	2 3/4"x10", #6MOR in, #6MOR out, PRV, Top Glass, Side Port with Low Pressure Switch	A22-14425-003	ABP N83 319014
M2	2006-08	Slim-line seal with top mounting	PH088539-00	ABP N83 319745
RELAY				

APPLICATIONS

MODEL	YEAR	DESCRIPTION	OEM P/N	ALLIANCE P/N
FREIGHTLINER				
PRESSURE SWITCH	1974-00	Relay, Blower, 12V, 20A/30A, Tab Mount, 5 Terminals	A22-011101-022	ABP N83 320140
All	1974-00	Relay, Compressor, 12V, 20A/30A, Tab Mount, 5 Terminals	ABP N83 320140	ABP N83 320140
All	1974-00	Relay, Blower, 12V, 30A/40A, Socket Mount	APB N83 320140	ABP N83 320140
All	1974-00	Relay, Compressor, 12V, 30A/40A, Socket Mount	POTVF415F11	ABP N83 320140
RESISTOR				
All	1990-06	Resistor, Blower Speed, Bakelite Back, 3 Terminal, 3 Speed	RDH RD5 3647 0 ABP N83 321060	ABP N83 321060
C, Century C112, Century C120, Columbia	1996-10	Blower resistor, 4 speed, 4 terminal	BOA-80-926-00-079 ABP N83 321350	ABP N83 321350
Century C112, Century C120	1997-10	Blower Resistor	RDH RD5 6450 0	ABP N83 321070
SWITCH				
All		Toggle switch with nickel plated toggle	RDH RD5 3827 2	ABP N83 322070
All		Toggle switch with 90 degree air fitting, ¼" in, ⅜" out	RDH RD5 4721 0	ABP N83 322075
All	1972-00	Valve, Solenoid, 12V, #6 MOR	207583 LA1225	ABP N83 308069
All	1990-06	Thermistor, CTC, 12V, Blower Speed Control	RDH RD6 4797 0 ABP N83 322925	ABP N83 322925
All	All	Rotary switch, 3 speed, DP3T, 4 position, 5 terminal	INM2G754A	ABP N83 323018
All	All	Toggle switch, SPST, 2 terminal	ABP N83 322030	ABP N83 322030
All	All	Toggle switch, SPST, 2 terminal	A06-11454-001	ABP N83 322030
All	All	Switch, Toggle, SPDT, ON-OFF-ON, 3 Terminal	A06-11454-001	ABP N83 322185
FL50, FL60, FL70, FL80, FL106, FL112	1993-00	Switch, Micro, 2 Terminal, with Arm	BOA-80-908-00-219	ABP N83 320220
FL50, FL60, FL70, FL80, FL106, FL112	1994-01	Toggle switch, DP3T, 4 position, 4 terminal	BOA-80-926-00-059	ABP N83 322135
FLB, FLL, FLD112, FLD120, FL50, FL60, FL70, FL80, FL106, FL112, Classic XL	1993-00	Switch, Rotary, 3 Speed, Short Shaft, 5 Terminal	BOA-80-926-00-059	ABP N83 322150
FLD112, FLD120, Classic XL	1999-01	Switch, Rotary, 3 Speed, Long Shaft, 5 Terminal	BOA-80-926-00-109	ABP N83 322190
FLD120, FLD112, Classic XL	1991-2010	Switch, Rotary, 3 Speed, Long Shaft, 5 Terminal	A06-14889-001	ABP N83 322190
THERMOSTAT				
C, Century C112, Century C120, Columbia	1998-10	Main unit with fixed setting thermostat	A630-008-00 BOA-80-946-00-079	ABP N83 323053
C, Century, Century S/T	1990-10	Main & Sleeper unit with fixed setting thermostat	BOA-80-946-00-109	ABP N83 323053
C, Century, Classic, Coronado, FL	1989-04	Adjustable, Cable Controlled, 30" Capillary	02-7010174	ABP N83 323014
FL50, FL60, FL70, FL80, FL106, FL112, FLB, FLL	1994-01	Main unit with fixed setting thermostat	BOA-80-946-00-079	ABP N83 323053
WATER VALVE				
Century C112, Century C120, Columbia	1996-02	Cable operated, Red Dot	A22-44463-001 A22-44553-000 MVA1-6296	ABP N83 324425
FL50, FL60, FL70, FL80, FL106, FL112, FLB, FLL, MB70	1992-01	Valve, Heater, Cable Controlled, ⅝" Hose, Offset, Pull to Close	KYS 173144 MA1425	ABP N83 324550

APPLICATIONS

MODEL	YEAR	DESCRIPTION	OEM P/N	ALLIANCE P/N
FREIGHTLINER				
THERMOSTAT				
FLB, FLD, FLL, FL50, FL60, FL70, FL80, FL106, FL112	1992-01	Cable Controlled, 5/8" Hose, Offset, Pull to Close	RDH RD5 8935 0	ABP N83 324430
FLB, FLD112, FLD120, FLL, Classic XL,	1991-00	Cable Operated (Bergstrom), mounts to core	MA1365	ABP N83 324525
FLD112, FLD120	1991-10	Cable operated, Red Dot, Main unit	A22-44553-000 MVA1-6296	ABP N83 324425
IHC - NAVISTAR				
ACCUMULATOR				
3200	All	Aluminum, Pad with Stud x #6 Tube Insert	3670134C1	ABP N83 319951
4,000,700,080,009,000	2007-10	With OE number 3666273C1	3666273-C1	ABP N83 319949
4200, 4300, 4400, 7300, 7400, 7500, 7600, 8500, 8600	2001-07	Aluminum, Pad Fittings with Studs, with Mounting Bracket	3542577-C2	ABP N83 319159
7300	After 10/10/2001	Aluminum, Pad Fittings with Studs, with Mounting Bracket	3542577-2	ABP N83 319159
9000, 9000i, ix, Eagle	2008-10	with Pad Mount Accumulator with OE#	3666273C1	ABP N83 319949
TerraStar	2012-2014	Aluminum , Pad Fittings with Studs	3839360C92 3843558C92 6102500C91	ABP N83 319041
ACTUATOR				
4000-4900, 50005900i, 6300, 7000-7700, 8000		2 Terminal, Actuator with Label #L6402515A	3542606C1	ABP N83 325407
All	All	Actuator	3542606C1 2611234C1	ABP N83 325407
All	All	Actuator	3599602C1	ABP N83 324028
All	All	Actuator	2503207C1	ABP N83 324030
AIR FILTER				
4000, 7000, 8000	All	A/C and heater filter, in cab, 13 1/2" x 13" x 3/4"	498144-C1 ZGG14265 ZGG720007	ABP N83 328505
4070A, 4070B	1980-2000	A/C and heater filter, in cab, 15" x 11" x 3/4"	480836-C1	ABP N83 328315
All		Mesh filter 9" x 9" x 5/8"	ZGG720002	ABP N83 328125
All		Mesh filter 30" x 10 3/8" x 3/8"	ZGG720008	ABP N83 328485
All		Mesh filter 28 1/2" x 7 1/8" x 1/16"	ZGG720006	ABP N83 328475
All		Mesh filter 22 1/2" x 10 1/4" x 3/4"	ZGG720005	ABP N83 328455
All	1995-10	All Series with OE # 1699956-C1	1699956-C1	ABP N83 328335
All	2000-2010	Air Filter	3839141C1	ABP N83 325517
All	2000-2010	Air Filter	2506656C1	ABP N83 325518
BLOWER MOTOR				
2000	1988-01	All with flange style motor (heavy duty)	2500485C1	ABP N83 301024
2000	1988-01	Flange Mount, 1 speed, 4 3/4" length, CW, No Wire	1699291C1	ABP N83 301781
4000, 5000, 5000i, 8000, ProStar	2009-11	All models Fan with wheel and OE#	3674285C1	ABP N83 301886
5000, 5000i	2000-11	with flange type motor and OE#	1699949C1	ABP N83 301054
5000i, 9100i, 9200i, 9400i, 9900i	2000-10	Main unit	1699949C1	ABP N83 301065
7300	After 10/1/01	Single Shaft, Flange Mount	3542611C2	ABP N83 301304

APPLICATIONS

MODEL	YEAR	DESCRIPTION	OEM P/N	ALLIANCE P/N
IHC - NAVISTAR				
BLOWER MOTOR				
All		OE style blower motor (only), 3 3/4" length, non-vented	411876C91 442987C1	ABP N83 301931
All		12V, CCW, 1 Speed, Single 5/16" Shaft, with Mounting Studs	1691717C91	ABP N83 301761
All		Double Shaft motor, 1 speed, 4 3/4" length	1691705C91	ABP N83 301352
All		12V, 1 Speed, Double 5/16" Shaft, WO/Mounting Studs	1691704C91 1691733C91	ABP N83 301072
CLUTCH ASSEMBLY				
4700		12V, PV8 Groove, 5 3/8", 1 Wire	1818128C1 1818128C2	ABP N83 303307
4900		12V, PV6 Groove, 5 3/4", 1 Wire	1687780C92 1687780C92	ABP N83 303287
9100		12V, 1A Groove, 6", 1 Wire	481800-C91 ZGG19311	ABP N83 303051
All		12V, 1A Groove, 6", 1 Wire	14190 481800C91 ZGG19311 ZGG12141	ABP N83 303051
All		Poly 8 groove, 4.9" diameter (125mm)	4427-9931 7730-9930 4734-6010	ABP N83 303157
All		Poly 8 groove, 5 1/8" diameter (130mm), metripak plug	4700-9931 4885-9931	ABP N83 303767
All		1 groove 1/2" width, 6" diameter pulley, 2 3/4" gaugeline, IHC plug	1653480C91 1653480-92 ZGG14191	ABP N83 303221
All		2 groove 1/2" width, 6" diameter pulley, 1 5/8" gaugeline, bullet plug	024-21590 1647566C91 165338C91 ZGG12135	ABP N83 303252
All		1 groove 1/2" width, 6 1/4" diameter pulley, 2 11/16" gaugeline, IHC plug	2016403C1 2016403C2 ZGG19845	ABP N83 303431
All		2 groove 1/2" width, 7" diameter pulley, 2" gaugeline, bullet plug, 24V	1140568C91	ABP N83 303342
All		1 groove, 5/8" width, 6" diameter groove, 2 11/16" gaugeline	393681C91	ABP N83 303281
All		12V, 2A Groove, 132MM, 1 Wire	576625C91 ZGG11207 8517-6014	ABP N83 303282
All		12V, 1A Groove-Overhang, 125MM, 1 Wire	1691736C1 ZGG16355	ABP N83 303261
All		12V, 2A Groove, 6", 1 Wire	165129C91 1647566C91 ZGG11566	ABP N83 303082
All		12V, 2A Groove, 7", 1 Wire	1687801C91 ZGG12136	ABP N83 303012
All		12V, PV6 Groove, 5 3/4", 2 Wire	ZGG704000	ABP N83 303277
All		12V, PV6 Groove, 5 7/8", 2 Wire	ZGG19323 ZGG704000	ABP N83 303187
All		12V, PV6 Groove, 6 1/8", 1 Wire	1687780C91 ZGG18414	ABP N83 303007
All		12V, PV8 Groove, 6 1/8", 2 Wire	ZGG19310	ABP N83 303123T

APPLICATIONS

MODEL	YEAR	DESCRIPTION	OEM P/N	ALLIANCE P/N
IHC - NAVISTAR				
CLUTCH ASSEMBLY				
All		12V, PV8 Groove, 6 1/8", 2 Wire	ZGG19310 ZGG19841	ABP N83 303123T
COMPRESSOR				
9800		7H15HD, MDA head, direct mt, poly 6, 4.9" (125mm) diameter	3541235C91 ZGG705017	ABP N83 304893
All		QP16HD, GWA fittings, ear mount, Poly 8 groove, 4 3/4" (123mm) 12v	3547916C1	ABP N83 304314Q
All		Sanden 4720, direct mount, poly 8, 119mm clutch	3808548C1	ABP N83 304216
All		IHC Models with Cummins 8.3L engine, Sanden #4647	2032287C91	ABP N83 304853Q
All		IHC Models with Detroit Series 60 engine, Sanden #4822	3551405C1	ABP N83 304403
All		FLX replacement, 2 groove, 5 1/4"(132mm) diameter	9285	ABP N83 304234
All		7H15HD GWA head, direct mt., poly 6 groove, (125mm) diameter	3541235-C91 3547916C1	ABP N83 304319Q
All		7H15SHD, MD head, direct mount, Poly 8 (152mm) diameter	4586 4109	ABP N83 304438
All		7H15HD, MDA head, direct mt, poly 6, 4.9" (125mm) diameter	3541235C91 ZGG705017	ABP N83 304893
All		7H15HD, JD head, direct mt, 2 groove, 5 1/4" (132mm) diameter	2032287C91	ABP N83 304102
All		7H15HD, JDA head, direct mt, poly 8, 4.7" (119mm) diameter		ABP N83 304403
All		QP15HD. 12V PV 6, 125mm, direct mount GWA head	3541235C91 4815	ABP N83 304319Q
All		QP15HD, 12V, 1A Groove Overhang, 125MM, 1 Wire, D Head	488-45063	ABP N83 304039Q
All		QP15HD, 12V, 2A Groove, 135MM, 1 Wire, D Head	488-45011	ABP N83 304025Q
All		QP15HD, 12V, 1 VAR Groove, 159MM, 1 Wire, D Head	488-45065	ABP N83 304015Q
All		QP15HD, 12V, 2A Groove, 135MM, 1 Wire, F Head, R-12	488-25011	ABP N83 304019Q
All		7H15HD, 12V, PV8 Groove, 119MM, 1 Wire, JDA Head	2003413C91 ZGG705130	ABP N83 304953
All		7H15HD, 12V, PV8 Groove, 119MM, 2 Wire, KC Head, Direct Mount	3579878C1	ABP N83 304973
All		Rotolock, LH Suction, #8 Discharge, #10 Suction, NO CLUTCH	417888C92 ER R210L- 21237 25062 25149 1676831C91 1676832C91 2502460C91	ABP N83 304171
All		Rotolock, LH Suction, #8 Discharge, #10 Suction, NO CLUTCH	417888C91	ABP N83 304171
All		Rotolock, LH Suction, #8 Discharge, #10 Suction, NO CLUTCH	417888C91 ER R210L- 21237 25062	ABP N83 304171

MODEL	YEAR	DESCRIPTION	OEM P/N	ALLIANCE P/N
IHC - NAVISTAR				
COMPRESSOR				
All		Tube-O, LH Suction, 1"-14 Discharge, 1"-14 Suction, NO CLUTCH	ET210L-25061 21160 25150C ZGG19254 1676832C91 1676832C92 1685127C91 2000820C91 2003413C91 2502459C91 2502460C91 417888C91 468323C91 417887C93 .	ABP N83 304031
All		Tube-O, LH Suction, 1"-14 Discharge, 1"-14 Suction, NO CLUTCH	ET210L-25061 21160 25150-C ZGG19254 1676832C91 1676832C92 1685127C91 2000820C91 2003413C91 2502459C91 2502460C91 417888C91 468323C91 417887C93 .	ABP N83 304031
All		Tube-O, LH Suction, 1"-14 Discharge, 1"-14 Suction, NO CLUTCH	1610046C91	ABP N83 304031
All		Tube-O, LH Suction, 1"-14 Discharge, 1"-14 Suction, NO CLUTCH	99244-5 ET210L-25061 21160 25150C	ABP N83 304031
All		GM A6, 1 groove ½" width, 4 ⅞" diameter (124mm), generic	509170C91	ABP N83 304008
All		QP15HD, 12V, 2A Groove, 135MM, 1 Wire, D Head	488-45077	ABP N83 304059Q
ProStar, DuraStar		Sanden 4418, direct mount, poly 8, 119mm clutch	3582435C1	ABP N83 304215
CONDENSER				
2000, 7000, 8000, 9000, 9200	1992-2002	Radiator Mount, IHC and Red Dot unit, #R-10035-1, -2, -3, -4	2004801C1 2004801C2 2004801C3 2004801C4	ABP N83 306018
4000, 8000	2008-11	with 20" x 23-½" x ⅝" Pad Fittings with OE#	2593329C91 1E5956	ABP N83 306330
5000, 5000i, 5360, 5500, 5500i, 5600i, 5870, 5900i	2001-06	23 ⅝" x 20 ⅜" x ⅝"	2585373C2	ABP N83 306327
7000, 7100, 7300, 7400, 7500, 7600, 7700, 8000-8600i, 9000-9900i	2001-07	Two connections	2507482C92	ABP N83 306325
8000, 8100, 8200, 8300, 8500, 8600, 8600i	2001-07	All with OE#	2586812C91 1E5633 2505650C92 3548907F93	ABP N83 306328
8000-8600i, 9000-9900i	2001-07	Block connection	2508698C92	ABP N83 306329

APPLICATIONS

MODEL	YEAR	DESCRIPTION	OEM P/N	ALLIANCE P/N
IHC - NAVISTAR				
CONDENSER				
All	1993-00	4600-4900 (7.3L engine)	2000655C2	ABP N83 306331
ProStar	2007-10	32 ¾" x 15 ¾" x ⅝"	2601445C91	ABP N83 306335
ProStar	2007-2010	Condenser	2591836C91 2591621C91	ABP N83 306337
ProStar	2010-11	ProStar with OE#	2593329C91	ABP N83 306330
EVAPORATOR				
5000-5900i, 9000-9900i	2000-12	10" x 13" x 2 ⅝"	1699950C1	ABP N83 307291
EXPANSION VALVE				
4000-4900	1983-00	Main unit, with O-Ring style valve	1691469C2	ABP N83 308105
5000i, 9100i, 9200i, 9400i, 9900i	2000-10	Main unit No Nick Type Expansion Valve	1699955C1 2501794C92	ABP N83 308281
9000-9900i	1997-06	Sleeper units	2501794C92	ABP N83 308281
9200, 9300, 9400, 9600, 9700, 9800	2000-02	Main unit no nick type (O-ring) valve	2503783C91	ABP N83 308261
All		Expansion Valve, Right Angle, Flare, with Capillary, with Equalizer	2684701C1	ABP N83 308015
All		Block, #6 #10 #8 #8, with Mounting Holes	431606-R1	ABP N83 308011
All	1995-01	Main unit no nick type (O-ring) valve	1696846C2 1696846C3 2503783C91	ABP N83 308261
ProStar	2007-10	Main Cab	3599589C1	ABP N83 308014
ProStar, LoneStar, 4000, 7000, 8000	2007-10	Main Cab	3660853C2	ABP N83 308022
S	1995-01	Main unit with Red Dot A/C	1696846C2	ABP N83 308261
FAN				
All		12 Volt Defroster Fan Assembly	783966C93	APB N83 309014
All	1979-02	All models with CW, plastic blower wheel	465502C1 1693199C1 BSM302001 ZGG14606	ABP N83 302006
All	2001-2011	6" dia CCW	1699947C1	ABP N83 302291
FILTER				
9200, 9400, 9800	1997-00	All with AC and heater intake 12" x 11" x ½" with OE#	1696834C1	ABP N83 328061
HEATER CORE				
4000, 7000, 8000		All with OE#	3542604C3 3542604C2 BOA-85-471-77-009	ABP N83 315023
5000-5900i, 9000-9900i	1982-01	9" x 11" x 1 ⅝" Main Cab	501099C91	ABP N83 315021
ProStar	2007-10	10 ⅜" x 6" x 1 ⅝" Auxiliary Sleeper	3599598C1	ABP N83 315022
ProStar	2007-10	Front Main Cab with OE#	3542604C3	ABP N83 315023
ORIFICE TUBE				
4000, 4200, 4300, 7500, 8000, 9000-9900i	2001-10	Main unit (NGV) - Behr Orifice Tube-Purple	3548044C1 BOA-80-305-00-949	ABP N83 308311
All	All	GM type, CCOT Orifice Tube-White with accumulator system, Main unit	1676822C91	ABP N83 308049
O-RINGS / SEALS				
All		O-ring Kit	3660865C1 2610414C1	ABP N83 325176
All		O-ring Kit	3824716C1 2610417C1	ABP N83 325177

MODEL	YEAR	DESCRIPTION	OEM P/N	ALLIANCE P/N
IHC - NAVISTAR				
O-RINGS / SEALS				
All		O-ring Kit	3661318C1 2610415C1	ABP N83 325178
All		O-ring Kit	3660864C1 2610413C1	ABP N83 325179
All		O-ring Kit	3660862C1 2610412C1	ABP N83 325181
PRESSURE SWITCH				
4000-4900, 5000-5900i, 8000-8600i	2006-10	Transducer M10 thread 3 pin Brown	3546241C1	ABP N83 318017
4600-4900, 8100, 8200, 8300, 9200-9700	1991-00	High pressure switch, normally closed 205psi, opens 375 psi, ¼" female flare	1676787C1 318000	ABP N83 318004
4600-4900, 8100-8300, 9200-9700	1991-00	Low pressure switch, normally closed 5psi, open 35 psi, M10 female flare	1676786C1 318004	ABP N83 318000
4600-4900, 8100-8300, 9200-9700	1991-00	High pressure switch, normally closed 205psi, opens 375 psi, ¼" female flare	1676787C1 318000	ABP N83 318004
9000	2001-05	High Pressure Normally Closed 275 / 225psi	3521729C1	ABP N83 318001
9200, 9300, 9400, 9900, 9900i	1985-00	Low pressure switch, normally open 11psi, close 39 psi, ¼" female flare	442183C1 442183C2 587977C1	ABP N83 318094
All		APADS switch high pressure	8040177P	ABP N83 318037
All		APADS switch low pressure	8040178P	ABP N83 318041
All	1993-03	Switch, Pressure, High, NO	1514307C1	ABP N83 318060
All	1993-05	Switch, Pressure, Trinary, NO	1691699C91	ABP N83 318009
All	1993-05	Switch, Pressure, Trinary, NO	1676658C1	ABP N83 318149
All	1998-03	Switch, Pressure, APADS, Low, NC	1699310-C1 8040136	ABP N83 318748
All	All	Accumulator Switch fits 3542577C2	3622764C3	ABP N83 322671
LoneStar, ProStar, TerraStar	2010-2014	Low Pressure Switch	3839315C1	ABP N83 318076
RECEIVER DRIER				
2000, 4600-4900, 5000, 8100-8300, 9200-9700	1993-08	3"x10", 1½" FOR in, #6 FOR out, PRV, Top Glass, R134A Service Port	1693117C1 2000821C1	ABP N83 319925
4600, 4700, 4800, 4900, 4954, 5000, 8100, 8200, 8300	1991-00	3"x8 ¼", #6 MOR in, #6 MOR out, PRV, Side Glass, Top Port	1676663C1	ABP N83 319110
9000-9900i	2001-2007	3"x10", 1½" FOR in, #6 FOR out, PRV, Top Glass, R134A Service Port	1693117C1	ABP N83 319925
9000-9900i	All	3"x10", 1½", QD in, QD out, Moisture Ind, (2) M10 Switch Ports	1607149C2	ABP N83 319725
9000-9900i	All	Quick disconnect, #6 male, #6 female outlet, 2 M10 ports		ABP N83 319625
All	1973-03	3"x10", 1½" FOR In, #6 FOR out, PRV, Top Glass	2000821C1	ABP N83 319910
All	1993-01	3"x10", QD In, QD out, PRV, Top Glass, R134A Service Port	2004050C1	ABP N83 319644
RESISTOR				
2000, 4600, 4700, 4900, 8100-8300	1991-02	Resistor, Blower Speed, Bakelite Back, 3 Terminal, 3 Speed	1696836-C1 650179	ABP N83 321300
2000-2600, 4000-4900, 8000-8600i	1977-01	IHC Resistor, 4 terminal, 4 speed	506552C1 BSM321010 ZGG14512	ABP N83 321201
4000, 4600, 4700, 4900, 5000, 7100, 7400, 8000, 9000-9900	2002-07	LPM Module 5 terminal	3562102C1	ABP N83 321004

APPLICATIONS

MODEL	YEAR	DESCRIPTION	OEM P/N	ALLIANCE P/N
IHC - NAVISTAR				
RESISTOR				
5000, 9000, ProStar	2007-10	LPM Module	3626414C1	ABP N83 321003
5000i, 9100i, 9200i, 9400i, 9900i	2000-04	Resistor, Blower Speed, Bakelite Back, 3 Terminal, 3 Speed	2500918-C1	ABP N83 321300
All	1977-00	Sleeper units with 3 terminal, 4 speed resistor	469458-C1	ABP N83 321201
All	1977-01	IHC Resistor, 4 terminal, 4 speed	506552C1 BSM321010 ZGG14512	ABP N83 321201
All	1991-01	Blower Resistor	506552C1	ABP N83 321201
ProStar	2010-2013	LPM Module	2510671C1	
SWITCH				
9300, 9370, 9400, 9400i, 9600, 9670, 9671, 9700	1981-01	Blower (fan) toggle switch, 10 terminal, OFF-ON-ON-ON	501087C1 501087C3 ZGG14469	ABP N83 322430
All	1976-03	Switch, Rotary, 3 Speed, Long Shaft, 5 Terminal	INM2G754A	ABP N83 322190
All	2001-08	Switch, Rotary, 3 Speed, Short Shaft, 5 Terminal	1661420C1	ABP N83 322150
All	All	Valve, Solenoid, 12V, #6 MOR	1669329C1 1669334C1	ABP N83 308069
ProStar	2007-2010	Blower Switch	3600338C1	ABP N83 322026
ProStar	2007-2010	Blower Switch	3600339C1	ABP N83 322027
THERMOSTAT				
5000, 7100, 9000, 9100, 9200, 9300, 9400, 9600, 9700	1973-01	Cable controlled thermostat, 43" cap tube	581691C1	ABP N83 323024
5500i, 5600i, 5900i, 9100, 9300, 9400, 9800	All	Fixed, 25" Capillary, 34°-44°, with Threaded Mounting Holes	1699953C1	ABP N83 323065
All		Fixed, 24" Probe	1676655C91 1691722C91	ABP N83 323010
All		Fixed, 24" Probe	1691726C91 3093422	ABP N83 323040
All		Fixed Setting thermostat with 16" capillary tube, flange mt.	1691729C91 BOA-80-946-00-079	ABP N83 323053
All		Adjustable, 36" Probe	175575C1	ABP N83 323118
All		Adjustable, 48" Capillary	301305C91	ABP N83 323108
All		Adjustable, Cable Controlled, 30" Capillary	445444C1	ABP N83 323014
All		All Models with factory air with rotary switch	A45-1033 13011C2	ABP N83 323088
All	1989-01	Fixed setting thermostat, 25" cap tube	1664248C1	ABP N83 323065
WATER VALVE				
4000-4900, 7000-7700, 8000-8600i	2001-07	with OE number	3542575C1 3542575C2	ABP N83 324027
9000, 9900i, ix, Eagle	1997-00	Water Shutoff (3/4" x 1/2" NPT)	367972C92 ZGG11080	ABP N83 324029
All		Cable Controlled, 5/8" Hose, STR-STR, Pull to Open	899996-R91	ABP N83 324050
All		Manual valve for 5/8" hose to 5/8" hose	ZGG14525	ABP N83 324020
All	2001-07	with OE number	3542575C1 3542575C2	ABP N83 324027
KENWORTH				
ACCUMULATOR				
All	1998-10	Accumulator Pad mount	F37-6063 18-04171	ABP N83 319072

APPLICATIONS

MODEL	YEAR	DESCRIPTION	OEM P/N	ALLIANCE P/N
KENWORTH				
ACCUMULATOR				
All	1998-10	Aluminum, 3 ½"x9 ⅜" Pad Fitting in, Pad Fitting out	F31-6063 18-04171	ABP N83 319072
ACTUATOR				
All	1996-03	Universal, 1½4V, 4 pin Deutz Connector, 104° Max Travel	MA14400 650341BSM	ABP N83 301458
AIR FILTER				
All	1993-2000	Filter, Cab Air	5X000190 5X000180	ABP N83 325516
All	1998-2010	Filter, Cab Air	5X010007	ABP N83 325515
All	2008-2010	Filter, Cab Air	5X013817	ABP N83 325514
T2000	2002-09	Filter, Cab Air	GD11800 525507BSM 525507	ABP N83 328333
BLOWER MOTOR				
All	1995-07	12V, CW, 1 Speed, Single ⅝" Shaft, with Mounting Studs	HA16050 HA1605 203076	ABP N83 301261
All	All	12V, Reversible, 1 Speed, Single ⅝" Shaft, with Mounting Studs	20322P 20332P	ABP N83 301033
All	All	24V, CCW, 1 Speed, Single ⅝" Shaft, with Mounting Studs	20303P	ABP N83 301321
All	All	12V, CW, 2 Speed, Single ⅝" Shaft, with Mounting Studs	20132P	ABP N83 301051
All	All	12V, CW, 1 Speed, Single ⅝" Shaft, with Mounting Studs	20152P1 20302P	ABP N83 301051
All	All	12V, 1 Speed, Double ⅝" Shaft, WO/Mounting Studs	20578P	ABP N83 301072
C500	1980-09	12V, 1 Speed, Double ⅝" Shaft, WO/Mounting Studs	HB16100 HB1610 203080 K318-201	ABP N83 301072
C500, C500B	1978-98	12V, CW, 1 Speed, Single ⅝" Shaft, with Mounting Studs	HA1105 HA1100	ABP-N83301051
K100, K100E	1983-07	12V, 1 Speed, Double ⅝" Shaft, without Mounting Studs	HB15700 HB1570 HB1680 203085 HA16050 HA1605 203076	ABP N83 301322
K100E	1986-07	12V, 1 Speed, Double ⅝" Shaft, without Mounting Studs	HB15700 HB1570 HB1680 203085	ABP N83 301322
T2000	1996-10	12V, 1 Speed, Double ⅝" Shaft, with Mounting Studs	HA15250 HA1525 203142BSM 871218BSM	ABP N83 301028
T2000	1996-12	12V, CW, 1 Speed, Single ⅝" Shaft, with Mounting Tabs	HA12600 203139BSM	ABP N83 301073
T270, T370, T470	2005-12	12V, CW, 1 Speed, Single ⅝" Shaft, Flange Mount	3X010983	ABP N83 301305
T300, T400, T600, W900	1997-01	12V, 1 Speed, Double ⅝" Shaft, without Mounting Studs	HA13500 203235BSM	ABP N83 301322
T700	2011-12	W/ Bergstrom main unit	203142BSM	ABP N83 301028

APPLICATIONS

MODEL	YEAR	DESCRIPTION	OEM P/N	ALLIANCE P/N
KENWORTH				
BLOWER MOTOR			HB16100	
W900	1980-12	12V, 1 Speed, Double 5/16" Shaft, WO/Mounting Studs	HB1610 203080	ABP N83 301072
W900	1995-97	12V, CCW, 1 Speed, Single 5/16" Shaft, with Mounting Studs	HA1120 2807-517-019	ABP N83 301761
BLOWER WHEEL				
All	1987-02	CW, Single Entry	HC12800 HC1280 1-1034Q 52980P	ABP N83 302051
All	1987-07	CW, Single Entry	HC1285 HC1280 HC 12800 52480P	ABP N83 302111
All	All	CCW, Single Entry	HC14000 HC1400 HC1015	ABP N83 302041
All	All	CCW, Single Entry	HC10250 HC1025 1-1033Q	ABP N83 302021
All	All	CCW, Single Entry	HC10250 HC1025 RD-3106-14	ABP N83 302021
All	All	CW, Single Entry	HC12800 HC1280 1-1034Q	ABP N83 302111
All	All	CW, Single Entry	HC16200 HC1620 RD-5-3800-1	ABP N83 302111
All	All	CW, Single Entry	HC1325 HC1405 260822 260830	ABP N83 302061
All	All	CW, Single Entry	HC13250 HC1325 RD5-5601-0	ABP N83 302061
All	All	Reversible, Double Entry	HC1075 1199001	ABP N83 302022
All	All	Reversible, Double Entry	RD-5-3933-1	ABP N83 302022
All	All	Reversible, Double Entry	302042	ABP N83 302052
C, T, W	1986-2010	w Bergstrom unit	589540	ABP N83 302321
LCF, Mid Ranger, 200, 210	1987-96	Reversible, Double Entry	HC13500 HC1350 RD5-5656 0	ABP N83 302032
T2000	1996-07	Reversible, Double Entry	HC10500 HC1050	ABP N83 302222
W900	1986-10	Reversible, Double Entry	HC10500 HC1050 589540	ABP N83 302222
CLUTCH ASSEMBLY				
All		12V, 1A Groove-Overhang, 125MM, 1 Wire	KA10550 KA1055 511869 511575 303261	ABP N83 303261

APPLICATIONS

MODEL	YEAR	DESCRIPTION	OEM P/N	ALLIANCE P/N
KENWORTH				
CLUTCH ASSEMBLY			KA1160	
All		12V, 2A Groove, 125MM, 1 Wire	6511-6210 511946 K322-39	ABP N83 303462
All		12V, 2A Groove, 132MM, 1 Wire	KA1075 6519-6010 KA1350 KA1345	ABP N83 303282
All		12V, PV7 Groove, 119MM, 1 Wire	4645-9931 6512-6210	ABP N83 303207
All		24V, 2A Groove, 125MM, 1 Wire	K332-B25 4611-9931	ABP N83 303003
All		12V, 2A Groove, 125MM, 2 Wire	KA44260 KA4426 4426-9931 1399068	ABP N83 303402
All		12V, 2A Groove, 125MM, 1 Wire	6511-6110 9353-6010	ABP N83 303232
All		12V, 1A Groove, 6", 1 Wire	KA10950 KA1095 K332-62-2 024-21942	ABP N83 303051
All		12V, PV6 Groove, 5 3/4", 2 Wire	KA14000 KA1400 024-25244 KA332-59-7	ABP N83 303277
All		12V, PV6 Groove, 5 3/4", 1 Wire	KA14100 KA1410 K332-59-3 024-25078 024- 25144	ABP N83 303287
All		12V, PV6 Groove, 5 7/8", 2 Wire	KA15350 KA1535 024-25241 K322-59-7	ABP N83 303187
All		12V, PV6 Groove, 6 1/8", 1 Wire	KA13900 KA1390 KA14000 KA1400 KA14800 KA1480	ABP N83 303007
All		12V, PV8 Groove, 5 3/8", 1 Wire	KA14850 KA1485 024 25247 14444 MA N05	ABP N83 303307
All		12V, PV8 Groove, 6 1/8", 2 Wire	KA14050 KA1405 024-25247 K332-59-4	ABP N83 303123T
All		12V, 2A Groove, 6", 1 Wire	KA10400 KA1040 K332-62-1 K332-19 K322-24 K322-27 5019390CC	ABP N83 303082

APPLICATIONS

MODEL	YEAR	DESCRIPTION	OEM P/N	ALLIANCE P/N
KENWORTH				
CLUTCH ASSEMBLY				
All		12V, 2A Groove, 6", 2 Wire	KA15250 KA1525 024-25238 K332-59-5	ABP N83 303063T
All		12V, 2A Groove, 7", 1 Wire	KA1090 332334 MA-7A	ABP N83 303012
COMPRESSOR				
All		Tube-O, LH Suction, 1"-14 Discharge, 1"-14 Suction, 12V, PV8 Groove, 6 1/8", 2 Wire	LC2125 ET210L-25246C	ABP N83 304201T
All		Rotolock, LH Suction, #8 Discharge, #10 Suction, NO CLUTCH	LC2000 LD1000 99239-5 ER210L-25149 K318-48-4	ABP N83 304171
All		Tube-O, LH Suction, 1"-14 Discharge, 1"-14 Suction, NO CLUTCH	LC2100 LD1030 99241-3 LD1035 99244-3 ET210L-25150	ABP N83 304031
All		Tube-O, LH Suction, 1"-14 Discharge, 1"-14 Suction, 12V, 2A Groove, 6", 1 Wire	LC1140 LC1015 ET210L-25073C	ABP N83 304101T
All		QP16HD, 12V, 8GRV, 119mm, GQ head	4705 F69-6002-212 18-04178	ABP N83 304279Q
All		QP16HD, 12V, PV8 Groove, 123MM, 2 Wire, H Head	LF0211 F69-6001-211 18-04178 252-1496	ABP N83 304279Q
All		QP15HD, 12V, 1A Groove Overhang, 125MM, 1 Wire, D Head	488-45063	ABP N83 304039Q
All		QP15HD, 12V, 2A Groove, 135MM, 1 Wire, D Head	103-55011 435-55011 488-45011	ABP N83 304025Q
All		QP15HD, 12V, 1 VAR Groove, 159MM, 1 Wire, D Head	435-55065 488-45065	ABP N83 304015Q
All		QP15HD, 12v direct mount GQ head, 119mm, Poly 8	F69-6003-111	ABP N83 304884Q
All		QP15HD, 12V Direct mount GH head, 125mm dia	F69-6003-122 4376 4079	ABP N83 304904Q
All		QP15HD, 12V, 1A Groove Overhang, 125MM, 1 Wire, F Head, R-12	488-25063 K318-36-02	ABP N83 304029Q
All		QP15HD, 12V, 2A Groove, 135MM, 1 Wire, F Head, R-12	LF1005 488-25011 K318-36-03	ABP N83 304019Q
All		QP15HD, 12V, 2A Groove, 135MM, 1 Wire, F Head, R-12	488-25077	ABP N83 304099Q
All		7H15HD, 12V, PV8 Groove, 119MM, 1 Wire, JDA Head	4645SAN 4645 LE1150	ABP N83 304953
All		7H15HD, 12V, 2A Groove, 125MM, 1 Wire, JDA Head	4647SAN LE1135 4664	ABP N83 304853Q

APPLICATIONS

MODEL	YEAR	DESCRIPTION	OEM P/N	ALLIANCE P/N
KENWORTH				
COMPRESSOR				
All		7H15HD, 12V, 2A Groove, 125MM, 1 Wire, JDA Head	4647SAN LE1135 F69-6001-253 LE1640 18-04088 4713SAN 4713	ABP N83 304853Q
All		7H15HD, 12V, PV8 Groove, 119MM, 1 Wire, JDA Head	4660	ABP N83 304344
All		7H15HD, 12V, PV8 Groove, 119MM, 1 Wire, MDA Head	4672SAN 4672 F69-6001-215	ABP N83 304873
All		5H14HD, 12V, 2A Groove, 132MM, 1 Wire, FL Head	LE1620 LE1035 4644	ABP N83 304102
All		7H15SHD, 12V, Direct mount, GQ head, 126mm, PV12	4078 F69-6003-151	ABP N83 304199
All		7H15SHD, PV8 Groove, 119mm, KCA head, direct mount	4090 4391	ABP N83 304435
All		7H15HD, 12V, 2A Groove, 125MM, 2 Wire, GQ Head	LF0231 F69-6002-231 4426SAN 4696SAN	ABP N83 304639
All		7H15HD, 12V, PV8 Groove, 119MM, 2 Wire, KG Head	4739SAN 4739 F69-6002-214 18-04291	ABP N83 304394
All		7H15SHD, PV8 Groove, 119mm, GSA head, direct mount	4081 4398	ABP N83 304458
All		7H15HD, 12V, PV8 Groove, 119MM, 2 Wire, KC Head, Direct Mount	LE1085 K318-103 4667SAN F69-6002-114	ABP N83 304973
All		7H15HD, 12V, 2A Groove, 125MM, 1 Wire, JD Head	LE1145 75R8422	ABP N83 304125
All		7H15HD, 12V, 2A Groove, 125MM, 2 Wire, JDA Head, Direct Mount	4740SAN 4740	ABP N83 304173
All		7H15HD, 12V, PV6 Groove, 125MM, 2 Wire, GSA Head, Direct Mount	4731 4424	ABP N83 304163
All		7H15HD, 12V, 2A Groove, 132MM, 2 Wire, JDA Head, Direct Mount	4626SAN 4626 4695 LE1140 1CC4696 F69-1000 F69-6001-153	ABP N83 304095
All		7H15HD, 12V, PV8 Groove, 119MM, 2 Wire, GQ Head, Direct Mount	4432 4759 F69-1003 F69-6002-111	ABP N83 304741
All		Tube-O, LH Suction, 1"-14 Discharge, 1"-14 Suction, 12V, 2A Groove, 6", 2 Wire	LC2120 ET210L-25237C	ABP N83 304141T

APPLICATIONS

MODEL	YEAR	DESCRIPTION	OEM P/N	ALLIANCE P/N
KENWORTH				
COMPRESSOR				
All	2000-06	7H15HD, 12V, PV6 Groove, 125MM, 2 Wire, GQ Head, Direct Mount	4425 4792 F69-6003-121 F69-6000 F69-6002-122	ABP N83 304481
CONDENSER				
K100, K100E	1983-05	Grilldenser, Non Functional	K137-189 K137-288	ABP N83 306615
T2000	1996-08	Radiator Mount	486684-5008 1514022	ABP N83 306620
T300	1988-96	Grilldenser, Non Functional, Aluminum Finish	K137-300-1	ABP N83 306605
T300	1988-96	Grilldenser, Non Functional, Black Finish	K137-300-2	ABP N83 306610
T300	1995-00	Radiator Mount	K122-128	ABP N83 306550
T300, T660, W900	2008-2012	Condenser	N4783001	ABP N83 306338
T400, T450, T470, T500, T600, T600A, T600B	1995-00	Radiator Mount	K122-125	ABP N83 306575
T400, T602, T603	1996-06	Grilldenser, Non Functional, Aluminum Finish	K137-299-1 RD4-5190-0	ABP N83 306590
T400, T602, T603	1996-06	Grilldenser, Non Functional, Black Finish	K137-299-2	ABP N83 306595
T700, T800, T2000	2008-12	Radiator Mount	N4778001 M3611002	ABP N83 306380
T800	1992-95	Radiator Mount	K122-102 RD4-4300-0	ABP N83 306530
W900B	1994-98	Radiator Mount	K122-121 RD4-4403-1	ABP N83 306260
EVAPORATOR				
13-210 Mid Ranger	1987-95	Evaporator Coil	NA11450 NA1145	ABP N83 307230
C500	1996-03	Evaporator Coil	NA10050 NA1005 151280	ABP N83 307300
C500, T300, T600, T800, W900	1995-09	Evaporator Coil	NA10900 NA1090 151328 NA10050 NA1005	ABP N83 307300
EXPANSION VALVE				
All		Right Angle, O Ring, with Capillary, with Equalizer	EA10200 EA1020 RD5-3824-1	ABP N83 308085
All		Right Angle, Flare, with Capillary, with Equalizer	EA10050 EA1005 RD4126-1	ABP N83 308015
All	1986-07	Block, #6 #10 #8 #8, with Mounting Holes	EA10650 EA1065 540031	ABP N83 308011
C500	1976-09	Block, #6 #10 #8 #8, with Mounting Holes 1.5 ton	EA10650 EA1065 404098	ABP N83 308011

MODEL	YEAR	DESCRIPTION	OEM P/N	ALLIANCE P/N
KENWORTH				
EXPANSION VALVE				
C500	1981-95	Right Angle, O Ring, with Capillary, with Equalizer	EA10200 EA1020 1-1845Q 404073 56380 EA12300 EA1230 576270	ABP N83 308085
C500, T270-T470, W900	2007-11	Block, M10, M12 ports 2 ton	540446BSM	ABP N83 308251
C500, T300, T400, T600, T800, W900	1995-08	Block, #6 #10 #8 #8, with Mounting Holes	EA10650 EA1065 540031 404098 EA1210	ABP N83 308011
K100, K100C, K100E	1982-07	Block, #6 #10 #8 #8, with Mounting Holes	EA10650 EA1065 RD4157-0 404098 D2953-5350	ABP N83 308011
T2000	1996-10	Block, #6 #10 #8 #8, Flange Mount, with M10 & M12 Schrader	540057	ABP N83 308141
T2000	1996-10	Block, #6 #10 #8 #8, Flange Mount	540056	ABP N83 308151
HEATER CORE				
All	1996-07	Heater Core	MC11350 MC1135 108263	ABP N83 315500
C500, T300, T400, T600, T800, W900	1995-10	Heater Core	MC10050 MC1005 110640	ABP N83 315350
PRESSURE SWITCH				
All	All	Switch, Pressure, APADS, High, NC	8040279P 8040135P 8040135	ABP N83 318718
All	All	Switch, Pressure, APADS, Low, NC	8040136P 8040152P 8040152	ABP N83 318748
All	All	ECM, APADS Controller	8042103P 8042103	ABP N83 318608
All	All	ECM, APADS Controller	8042105	ABP N83 318638
C500, K100, T400	1981-07	Switch, Pressure, High, NC	18-03835 79PSL2	ABP N83 318170
C500, K100, T400, T450, T470, T500, T600, T600A, T600B, T602, T603, T660, T700, T800, T800B, T800H, T800W, W901	1981-08	Fan Override switch (gray) M10 NC	P93CAA-3606-01 K301-370-1	ABP N83 318104
C500, K100, T400, T450, T470, T500, T600, T600A, T600B, T602, T603, T660, T700, T800, T800B, T800H, T800W, W900	2006-08	Dual function (Brown) M10, NC, 330-370psi	79PSD4-1 K301-370-1	ABP N83 318027

APPLICATIONS

MODEL	YEAR	DESCRIPTION	OEM P/N	ALLIANCE P/N
KENWORTH				
PRESSURE SWITCH				
C500, W900B, T2000, T270, T300, T370, T400, T450, T470, T500, T600, T600A, T600B, T602, T603, T660, T700, T800, T800B, T800H, T800W, K100E	1989-99	Switch, Pressure, High, NC	BB10250 BB1025 867559	ABP N83 318030
C500, W900B, T2000, T270, T300, T370, T400, T450, T470, T500, T600, T600A, T600B, T602, T603, T660, T700, T800, T800B, T800H, T800W, K100E	1989-99	Switch, Pressure, Trinary, NO	BC10050 BC1005 RD5-4585-0	ABP N83 318009
C500, W900B, T2000, T270, T300, T370, T400, T450, T470, T500, T600, T600A, T600B, T602, T603, T660, T700, T800, T800B, T800H, T800W, K100E	1989-99	Switch, Pressure, Trinary, NC	BA12650 BA1265 RD5-4620-0	ABP N83 322175
T2000	1998-07	Switch, Pressure, High, NC w M10 port	650697BSM	ABP N83 318170
RECEIVER DRIER				
C500, K100, T400, T450, T600, T800, W900B	1994-02	3"x10", Quick Connect in, Quick Connect out, Side Glass, Moisture Indicator	JA20350 JA2035 PH088341-00	ABP N83 319654
C500, K100, T400, T450, T600, T800, W900B	1994-07	3"x10", #6FOR in, #6MOR out, Side Glass, Moisture Indicator	GD11350 GD1135 K251-571 RD5-8254-0 F37-1003	ABP N83 319027
T2000	1996-10	3"x10 1/16", Slimline Manifold Block	JA22250 JA2225 F37-6000C	ABP N83 319575
RELAY				
All	1986-10	Relay, Blower, 12V, 20A/30A, Tab Mount, 5 Terminals	CB11150 CB1115 652420	APB N83 320140
All	1986-10	Relay, Blower, 24V, 20A/30A, Tab Mount, 5 Terminal	CB10750 CB1075 RD5-4417-0	ABP N83 320280
All	1986-10	Relay, Blower, 12V, 15A, Socket Mount, 8 Terminal	CB10100 CB1010 RD5-5027-1	ABP N83 320170
All	1986-10	Relay, Blower, Twin Temp, 12V, 10A, Socket Mount, 8 Terminal	CB10250 CB1025 RD4370-0	ABP N83 320120
All	All	Relay, Blower, 12V, 20A/30A, Tab Mount, 5 Terminals	CB10050 CB1005 RD5-4408-0	APB N83 320140
T2000	1986-10	Relay, Blower, 12V, 20A/30A, Tab Mount, 5 Terminals	CB11150 CB1115	APB N83 320140

APPLICATIONS

MODEL	YEAR	DESCRIPTION	OEM P/N	ALLIANCE P/N
KENWORTH				
RESISTOR				
C500, K100E, T2000, T270, T300, T370, T400, T450, T470, T500, T600, T600A, T600B, T602, T603, T660, T700, T800, T800B, T800H, T800W, W900B	1995-09	Resistor, Blower Speed, Bakelite Back, 3 Terminal, 3 Speed	CA10350 CA1035 650179	ABP N83 321300
SWITCH				
All	1976-01	Solenoid, 12V, Fan Clutch Air Control	BA12450 BA1245 RD5-0060-0	ABP N83 322390
All	1976-01	Switch, Air, Push Button, Chrome	BA12350 BA1235 RD5-3827-4	ABP N83 322165
All	All	Switch, Rocker, 5 Terminal	BE10050BE1005 RD-4225-2	ABP N83 322355
All	All	Switch, Rocker, 6 Terminal	BA10400 BA1040 RD-4151-4 K301-19	ABP N83 322205
All	All	Switch, Rocker, 5 Terminal	BA12600 BA1260 RD-4151-2	ABP N83 322325
All	All	Switch, Rocker, 5 Terminal	BA10300 BA1030 223183 RD5-3599-0P	ABP N83 322375
C500, K100, T400, T450, T470, T500, T600, T600A, T600B, T602, T603, T660, T700, T800, T800B, T800H, T800W, W900B	1981-97	Circuit Breaker, 30A, Push Button Reset	CC10200 CC1020 K1110-0552-30	ABP N83 320060
C500, K100, W900, W900B, W900L	All	Switch, Toggle, 3 Terminal	BE10250 BE1025 RD-4225-1 K301-89	ABP N83 322350
C500, K100E, W900B, T2000, T270, T300, T370, T400, T450, T470, T500, T600, T600A, T600B, T602, T603, T660, T700, T800, T800B, T800H, T800W	1981-00	Switch, Micro, 3 Terminal, with Arm	BA10800 BA1080 652100	ABP N83 322435
C500, K100E, W900B, T2000, T270, T300, T370, T400, T450, T470, T500, T600, T600A, T600B, T602, T603, T660, T700, T800, T800B, T800H, T800W	1986-00	Switch, Bent Lever, 5 Terminal	BA10050 BA1005 652090	ABP N83 322003
C500, K100E, W900B, T2000, T270, T300, T370, T400, T450, T470, T500, T600, T600A, T600B, T602, T603, T660, T700, T800, T800B, T800H, T800W	1996-07	Switch, Rotary, 3 Speed, Long Shaft, 5 Terminal	BA10650 BA1065 FG1005 651690	ABP N83 322190

APPLICATIONS

MODEL	YEAR	DESCRIPTION	OEM P/N	ALLIANCE P/N
KENWORTH				
SWITCH				
C500, K100E, W900B, T2000, T270, T300, T370, T400, T450, T470, T500, T600, T600A, T600B, T602, T603, T660, T700, T800, T800B, T800H, T800W	1996-08	Switch, Micro, 2 Terminal, with Arm	BA10800 BA1080 BA1045	ABP N83 320220
C500, W900	All	Switch, Rocker, 3 Terminal	BA12950 BA1295 RD-4151-1	ABP N83 322320
Conventional	1976-01	Valve, Solenoid, 12V, #6 MOR	CD1000 RD4188-0	ABP N83 308069
T2000	1996-05	Circuit Breaker, 15A, Push Button Reset	CC10150 CC1015 K1110-0548-15	ABP N83 320050
T2000	1996-05	Circuit Breaker, 20A, Push Button Reset	K1110-0548-20	ABP N83 320052
T300	2006	Switch, Rotary, 3 Speed, Long Shaft, 5 Terminal	BA13900 BA1390 650657	ABP N83 322190
THERMOSTAT				
13-210 Mid Ranger	1987-96	Fixed, 24" Probe	BD11050 BD1105 404145	ABP N83 323010
13-210 Mid Ranger	1987-96	Fixed, 24" Probe	BD10750 BD1075 RD4427-24	ABP N83 323040
All	All	Adjustable, 48" Capillary	BD10350 BD1035 BD1025 1-4185Q 404082	ABP N83 323108
C500, T300, T600, T800, W900	1991-08	Fixed, 12" Probe	BD13550 BD1355 650163BSM	ABP N83 323050
K100E	1986-02	Fixed, 24" Probe	BD11050 BD1105 589490	ABP N83 323010
T2000	1996-10	Fixed, 12" Probe	BD13550 BD1355 RD5-8938-0 650163BSM	ABP N83 323050
WATER VALVE				
All		Cable Controlled, 5/8" Hose, STR-STR, Pull to Open	MA10600 MA1060 MA1115 1-1574Q RD5-5119-0	ABP N83 324010
All		Cable Controlled, 5/8" Hose, STR-STR, Pull to Close	MA11000 MA1100 RD-5-5300-0	ABP N83 324080
All		Cable Controlled, 5/8" Hose, STR-90°, Pull to Open	MA12850 MA1285 RD5-5495-1	ABP N83 324080

APPLICATIONS

MODEL	YEAR	DESCRIPTION	OEM P/N	ALLIANCE P/N
KENWORTH				
WATER VALVE				
All		Air Controlled, 3/4" Hose, 90°	MA10500 MA1050 RD5-4797-0 RD5-8859-0	ABP N83 324565
All	1983-00	Cable Controlled, 5/8" Hose, STR-STR, Pull to Open	MA10650 MA1065 RD5-4923-0	ABP N83 324215
All	1983-00	Cable Controlled, 5/8" Hose, STR-STR, Pull to Open	MA12750 MA1275 RD4257-0	ABP N83 324050
All	1983-00	Cable Controlled, 5/8" Hose, Offset, Pull to Close	MA1165 173096 869639	ABP N83 324430
All	1983-02	Cable Controlled, 5/8" to 3/4" Hose, STR-STR, Pull to Open	MA1345 DA1020 RD5-3877-0	ABP N83 324445
All	1987-00	Air Controlled, 5/8" Hose, Offset	MA10850 MA1085 RD5-5138-0	ABP N83 324015
All	1987-02	Air Controlled, 5/8" Hose, 90°	MA10200 MA1020 RD5-4800-0 RD5-8804-0 K295-193	ABP N83 324400
MACK				
ACTUATOR				
All		Single action air cylinder, 3/4" diameter, 3 3/4" length	4379-RD32671	ABP N83 318183
All		Actuator, Air, Single Action	4379-RD554144	ABP N83 318113
All		Actuator, Air, Single Action	4379-RD557845	ABP N83 318083
All		Actuator, Air, Double Acting	4379-RD554241	ABP N83 318123
MR (Oscar)	2007-08	Universal, 1 1/2" V, 4 pin Deutz Connector, 104° Max Travel	4379-RD5118620	ABP N83 301458
BLOWER MOTOR				
All		Motor, 12V, CW, 1 Speed, Single 5/16" Shaft, with Mounting Studs	7979-274070	ABP N83 301004
All		Motor, 12V, CW, 1 Speed, Single 5/16" Shaft, with Mounting Studs	7979-275130	ABP N83 301101
All		Heater blower motor, 1 speed, CW, 4" length	4379-RD556340	ABP N83 301097
All	1979-86	Motor, 12V, CCW, 1 Speed, Single 5/16" Shaft, with Mounting Studs	4379-RD310618	ABP N83 301191
All	1981-86	Motor, 12V, CCW, 2 Speed, Single 5/16" Shaft, with Mounting Studs	4379-RD310613	ABP N83 301131
All	1986-93	Motor, 1 speed, CW, 4" length, Sleeper Series (C.O.E.) with Bunk Blower	4379-RD556341	ABP N83 301097
All	1987-94	Motor, 12V, CCW, 1 Speed, Single 5/16" Shaft, with Mounting Studs	4379-RD565261	ABP N83 301761
All	1995-02	Sleeper Series with Red Dot Model R-4230/R-4240	4379-RD582030	ABP N83 301331
C.O.E.	1986-96	Motor, 12V, 1 Speed, Double 5/16" Shaft, with Mounting Studs	4379-RD554350	ABP N83 301411
C.O.E., Conventional	1986-93	Motor, 12V, 1 Speed, Double 5/16" Shaft, with Mounting Studs	HA1175 203174 203178	ABP N83 301411
CH	1988-02	Red Dot A/C, single shaft, CCW, 4 13/32" length	4379-RD582030	ABP N83 301331

APPLICATIONS

MODEL	YEAR	DESCRIPTION	OEM P/N	ALLIANCE P/N
MACK				
BLOWER MOTOR				
CH, CL	1988-00	Sleeper Unit, heater blower motor, 1 speed, CW, 4" length	4379-RD591020	ABP N83 301097
CM	1988-97	Main unit with single shaft, 4 7/8" length	HA1695 4379-RD559070	ABP N83 301421
Conventional	1985-91	Motor, 12V, 1 Speed, Double 5/16" Shaft, with Mounting Studs	HA1700	ABP N83 301411
CS Midliner	1986-96	Motor, 12V, 1 Speed, Double 5/16" Shaft, with Mounting Studs	7979-275102	ABP N83 301172
CS Midliner Conv	1988-93	Motor, 12V, CCW, 1 Speed, Single 5/16" Shaft, with Mounting Studs, RFI Shielded	HA1060 4379-RD582040	ABP N83 301121
CS Midliner Conv	1990-02	Motor, 12V, 1 Speed, Double 5/16" Shaft, with Mounting Studs	4379-RD551210	ABP N83 301192
CX, Vision	1999-00	Motor, 12V, CW, 1 Speed, Single 5/16" Shaft, with Mounting Studs	4379-RD591000	ABP N83 301004
CX, Vision	2000-08	Main Unit Bergstrom system	7787-869445	ABP N83 301987
F	1975-81	Motor, 12V, 1 Speed, Double 5/16" Shaft, with Mounting Studs	2790-275140	ABP N83 301192
LE	1993-00	Main unit	4379-RD552692	ABP N83 301821
MH Ultraliner	1986-94	Motor, 12V, CW, 1 Speed, Single 5/16" Shaft, with Mounting Studs	4379-RD555120	ABP N83 301261
MR (Oscar)	2007-08	2RD570M Unit with Heater A/C, 12V blower motor assy	RD 5 8837 0	ABP N83 301282
MR (Oscar)	2007-08	2RD570M2, M3 Unit with heater only, Unit with Heater A/C, 12V double blower motor only	4379-RD5123580	ABP N83 301194
MS Midliner	1979-01	Motor, 12V, 1 Speed, Double 5/16" Shaft, with Mounting Studs	275102-060	ABP N83 301172
R, RL, RS, RW, U, DM	1981-85	with Kysor Mini-Brute Combo A/C, heater blower motor, 1 speed, CW, 4" length	2790-275160	ABP N83 301097
R, U, DM Conventional	1975-93	Heater Only (Flanged Motor)(Evans) Black		ABP N83 301275
R, U, DM Conventional	1987-93	Motor, 12V, CW, 1 Speed, Single 5/16" Shaft, with Mounting Studs	4379-RD537530 4379-RD565260	ABP N83 301001
WL, WS	1981-86	Motor, 12V, CW, 1 Speed, Single 5/16" Shaft, with Mounting Studs	4379-RD565260	ABP N83 301001
BLOWER WHEEL				
C.O.E.	1986-94	CW, Single Entry	4379-RD538001	ABP N83 302111
CS, CS Midliner	1982-00	Reversible, Double Entry	7979-260680	ABP N83 302032
CS, CS Midliner Conventional	1990-02	Red Dot A/C with 3 5/16" double entry wheel, 3 3/4" width	4379-RD348291	ABP N83 302012
CX	2000-01	Main unit	4379-RD566511	ABP N83 302251
DM C.O.E.	1979-86	CCW, Single Entry	4379-RD310614	ABP N83 302021
DM, DM C.O.E.	1979-86	CCW, Single Entry	4379-RD31069	ABP N83 302041
DM, DM C.O.E., DMM	1979-99	CW, Single Entry	4379-RD552630	ABP N83 302051
LE	1993-00	Reversible, Double Entry	HC1300 4379-RD325572	ABP N83 302002
MC	1986-99	Reversible, Double Entry	4379-RD539330	ABP N83 302022
MS, MS Midliner	1990-99	Reversible, Double Entry	4379-RD556560	ABP N83 302032
R, RW, RL, RS C.O.E.	1979-86	CCW, Single Entry	4379-RD31069 HC1015	ABP N83 302041
CLUTCH ASSEMBLY				
All		12V, 2A Groove, 132MM, 1 Wire	6574-6210 6514-6210	ABP N83 303282

APPLICATIONS

MODEL	YEAR	DESCRIPTION	OEM P/N	ALLIANCE P/N
MACK				
CLUTCH ASSEMBLY				
All		12V, 1A Groove-Overhang, 125MM, 1 Wire	511869 4379-RD566460	ABP N83 303261
All		12V, 2A Groove, 6", 1 Wire	IMX240 1MXA1280 10884	ABP N83 303082
All		12V, 2A Groove, 7", 1 Wire	IMX246 7534 332334	ABP N83 303012
All		2 groove 6" diameter pulley, 1/2" width, 1 5/8" ga, bullet plug	IMX242 7531 332639	ABP N83 303252
All		1 groove, 6 3/4" diameter pulley, 1/2" width, 1 3/4" gaugeline, bullet plug	1MXA3217 10582 502731	ABP N83 303071
All		2 groove 5 23/64" 135mm diameter pulley, 1/2" width, bullet plug	2570151 624-19724	ABP N83 303712
COMPRESSOR				
All		QP15HD, 12V, 1A Groove Overhang, 125MM, 1 Wire, D Head	488-45063 4379-RD589440	ABP N83 304039
All		QP15HD, 12V, 2A Groove, 135MM, 1 Wire, D Head	488-45011 4379-RD571450	ABP N83 304025
All		QP15HD, 12V, 1 VAR Groove, 159MM, 1 Wire, D Head	488-45065 4379-RD571640	ABP N83 304015
All		QP15HD, 12V, 2A Groove, 135MM, 1 Wire, F Head, R-12	488-25011 4379-RD558760	ABP N83 304019
All		QP15HD, 12V, 2A Groove, 135MM, 1 Wire, F Head, R-12	488-25077 4379-RD570230	ABP N83 304099
All		7H15SHD, 12V, PV 8 Groove, 132mm, WV head, Direct mount	4493 4733 4892 20501067	ABP N83 304634
All		7H15SHD, 12V, PV 6 Groove, 132mm, WV head, Direct mount	4494 4757 4891 20501069	ABP N83 304624
All		7H15SHD, 12V, 2A Groove, 132mm, WV head, Ear mount	4717 4777 4893 85104592	ABP N83 304574
All		SD7H15, 12v 2A Groove 125mm, QD head Ear mount	7803 15653237	ABP N83 304652
All		7H15HD, 12V, 2A Groove, 125MM, 1 Wire, JD head	4379-RD571200 4627	ABP N83 304125
All		7H15HD, 12V, 2A Groove, 132MM, 2 Wire, JDA head, Direct Mount	206RD49AM 4626	ABP N83 304095
All		7H15SHD, 12V, 2A Groove, 132mm, WV head, Direct mount	4715 4890 85104593	ABP N83 304213
All		Rotolock, LH Suction, #8 Discharge, #10 Suction, NO CLUTCH	99242-5 ER210L-25149	ABP N83 304171
All		Tube-O, LH Suction, 1"-14 Discharge, 1"-14 Suction, NO CLUTCH	99244-5 ET210L-25150	ABP N83 304031
All		QP15HD, 12V, 2A Groove, 135MM, 1 Wire, D Head	488-45077 4379-RD596091	ABP N83 304059

APPLICATIONS

MODEL	YEAR	DESCRIPTION	OEM P/N	ALLIANCE P/N
MACK				
COMPRESSOR				
All		7H15HD, JD head, ear mount, 2 groove, 5 ¼" (132mm) diameter	206RD413M 4639	ABP N83 304102
All		7H15HD, JDA head, direct mount, poly 8, 4.7" (119mm) diameter	4822	ABP N83 304403
All		7H15HD direct mount, poly 6 gr. (125mm) diameter, 2 wire	206RD51M 20514024 4883	ABP N83 304241
All		7H15SHD, WV head direct mount, poly 8, (180mm) diameter	4326E 4326	ABP N83 304994
All		SPRHD, WV head, direct mount, 8 groove, 7" (180mm) diameter	206RD53M 4326	ABP N83 304994
CONDENSER				
All		Red Dot Roof Mounted A/C	4379-RD438741	ABP N83 306130
All	2000-2008	Condenser Coil	210RD59M	ABP N83 306334
CH	1994-1998	Main unit radiator mount, serpentine coil	210RD421M 4379-RD457620	ABP N83 306885
CH	2000-08	Main unit radiator mount, serpentine coil	210RD411M 4379-RD457460	ABP N83 306290
CH, CH600 Construction	1986-03	Main unit radiator mount, serpentine coil	210RD54M	ABP N83 306910
CH,CL,CX	2008-12	Main unit radiator mount, serpentine coil	210RD290	ABP N83 306022
CS, MS Midliner	1983-01	Main unit with 12V auxillary fan	4379-RD441442	ABP N83 306225
DH, DM	1991-93	All series with with factory A/C	210RD412M	ABP N83 306895
DM Conventional	1968-80	with Charge Air with Male O-Ring Fittings	4379-RD451461	ABP N83 306300
DM Conventional	1980-89	with charge air fittings, serpentine coil	210RD46AM 4379-RD442320	ABP N83 325142
DM, DM 600 Construction	1976-05	All series with with factory A/C	210RD410M	ABP N83 306890
MH	1972-84	Cab over	210RD46AM-R.H.	ABP N83 306915
MR	1994-1998	All with factory A/C	210RD424	ABP N83 306324
MR, MR600	1982-05	All series with with factory A/C	210RD413	ABP N83 306900
R, U Conventional	1976-89	All series with with factory A/C, grilldenser coil	210RD277P2	ABP N83 306015
RD, RD688S	2003	All series with with factory A/C	210RD422	ABP N83 306323
RD, RD688S	1995-97	All series with with factory A/C	210RD418	ABP N83 306905
RL, RS, RW	1984-95	Condenser coil only for hood mount, grilldenser coil	210RD48	ABP N83 306000
RW, RWL, RWS	1990-91	with hood mount grilldenser coil	4379-RD435952	ABP N83 306165
Vision	2000-2007	Condenser Coil	210RD517M	ABP N83 306336
CONTROL CABLE				
MR (Oscar)	2007-08	2RD570M, M2, M3 Unit, 60" length	RD 5 6410 60	ABP N83 327888
EVAPORATOR				
All	1995-02	Sleeper Unit	4379-RD218981	ABP N83 307565
CH, CL Conventional	1988-01	Main unit (Red Dot)	4379-RD216550	ABP N83 307095
DM, DMM	1987-02	Main unit (with drain pan)	4379-RD214801	ABP N83 307195
MC, MR	1986-04	Evaporator Coil	4379-RD213810	ABP N83 307185
MS Midliner	1990-99	Evaporator Coil	4379-RD215100	ABP N83 307230
WL, WS, Cruiseline	1975-84	Main unit (Red Dot)	4379-RD211560	ABP N83 307160
EXPANSION VALVE				
All	1979-93	Block, #6 #10 #8 #8, with Mounting Holes	4300-57104 4379-RD568680	ABP N83 308011
All	1982-93	Main unit with Signet A/C	3230-218023	ABP N83 308105

MODEL	YEAR	DESCRIPTION	OEM P/N	ALLIANCE P/N
MACK				
EXPANSION VALVE				
CH Conventional	1988-00	Block, #6 #10 #8 #10, with Mounting Holes	4379-RD570150	ABP N83 308071
CH, Vision, Granite	2003-2013	Block, #6 #12 #8 #10 with Mount Holes	20443850	ABP N83 308022
CS, MS Midliner, Magirus 200, Magirus 300, CS200-2	1979-93	Block, #6 #10 #8 #8, with Mounting Holes	4379-RD568680	ABP N83 308011
CX	2000-02	Main unit, Hi - capacity (2 ton), (Red Dot)	4379-RD5105460	ABP N83 308125
DM	1976-93	Block, #6 #10 #8 #8, with Mounting Holes	7979-404098	ABP N83 308011
DM, F C.O.E.	1975-94	Right Angle, O Ring, with Capillary, with Equalizer	7979-404073 4379-RD538241	ABP N83 308085
MR (Oscar)	2007-08	Block, #6 #10 #8 #8, with Mounting Holes	RD 5 6868 0	ABP N83 308011
FAN				
All		Fan, Defrost, Universal, 12 Volt, 2 Speed	96-14 101RD35-P1 101RD41-P2	ABP N83 309141
HEATER CORE				
All	1979-81	Heater Core	4379-RD103330	ABP N83 315105
All	1981-83	Heater Core	4379-RD103710	ABP N83 315140
All	1987-00	Sleeper Unit (withCTC)	4379-RD105630	ABP N83 315160
All	1987-94	Heater Core	4379-RD106650	ABP N83 315055
All	1995-02	Heater Core	4379-RD108221	ABP N83 315955
DM, DMM	1981-01	Heater Core	4379-RD101471	ABP N83 315100
DM, DMM	1988-02	Main unit (without Drainpan)	4379-RD106151	ABP N83 315220
Granite	2003-06	Main unit with Red Dot A/C	4379-RD107440	ABP N83 315230
MC, MR	1986-02	Main unit with Red Dot A/C	4379-RD105500	ABP N83 315210
MR (Oscar)	2007-08	2RD570M3 Unit with heater only, HP heater core	4379-RD105500	RDH RD1 0552 0
PRESSURE SWITCH				
All		Switch, Pressure, Low, NO	4379-RD41910	ABP N83 318014
All		All with APAds electronic pressure switch	4379-RD5107690	ABP N83 318818
All	1980-01	with Red Dot A/C, Trinary Switch with harness	4379-RD5121500	ABP N83 318131
All	1980-01	Switch, Pressure, Trinary, NO	4379-RD545830	ABP N83 318149
All	1980-01	Switch, Pressure, Trinary, NO	4379-RD545850	ABP N83 318009
All	1995-04	ECM, APADS Controller	4379-RD5103520	ABP N83 318638
CH	1994-03	Micro Switch	4379-RD584900	ABP N83 320220
CH, CHN, CL, CM, CS Conventional	1996-05	Micro Switch	4379-RD568330	ABP N83 322435
CH, CHN, CL, CM, CS Conventional	1996-06	with Red Dot A/C, Binary Switch	4379-RD546400	ABP N83 318089
CS, MS Midliner, Magirus	1978-94	Switch, Pressure, High, NC	4379-RD558730 7979-404141	ABP N83 318030
Granite, Titan	2002-09	Dual Function M10 Port NC	4379-RD589460 1MR3550M	ABP N83 318209
R, RL, RS, RW, U, DM	1983-00	with Red Dot A/C, Binary Switch	4379-RD546460	ABP N83 318079
R, RL, RS, RW, U, DM	1983-93	with Red Dot A/C, Trinary Switch	4379-RD563950	ABP N83 318084
RECEIVER DRIER				
All		#6 male O-Ring, 2 3/4" x 10 5/8", without trinary switch	4379-RD565672	ABP N83 319130
All	1986-97	O-Ring type with female switch port & moisture indicator	221RD333	ABP N83 319633

APPLICATIONS

MODEL	YEAR	DESCRIPTION	OEM P/N	ALLIANCE P/N
MACK				
RECEIVER DRIER				
All	1993-03	O-Ring type with metric ports and moisture indicator	221RD331 334 335	ABP N83 319505
CH, CL, CM	1988-98	#6 male O-Ring, 2 3/4" x 10", without binary switch	221RD327P 328P 4379-RD555720	ABP N83 319004
CH,CL,CX, Vision, Titan	2006-11	O-Ring Type 3" by 9" with moisture indicator	221RD44M	ABP N83 319671
Conventional	1983-94	O-Ring Type with Kysor MiniBrute A/C	7979-402492 7979-402562	ABP N83 319291
CS, MS Midliner	1983-94	O-Ring Type with Kysor A/C	7979-402562	ABP N83 319291
CS, MS Midliner	1988-91	O-Ring Type with Behr A/C	JA1045	ABP N83 319291
CS, MS Midliner	1989-00	O-Ring Type with Red Dot A/C	4379-RD570611	ABP N83 319211
CS, MS Midliner	1989-00	O-Ring Type with Red Dot A/C	4379-RD570610	ABP N83 319271
CX	2005-07	O-Ring Type with Metric Ports and Moisture Indicator	221RD335	ABP N83 319505
CX, CXU, CXN, CTP	2007-13	O-Ring Type 3" by 9" with moisture indicator	82733985	ABP N83 319671
DM	1977-93	2 3/4"x9 5/8", #6MOR in, #6 MOR out, PRV, Side Glass, Top Port with Trinary Switch	4379-RD546321	ABP N83 319074
DM	1977-93	O-Ring Type with side port, top glass, moisture indicator	221RD32	ABP N83 319289
DM	1994-02	O-Ring Type with Standard Ports and Moisture Indicator	221RD334	ABP N83 319555
DM Conventional	1977-93	2 3/4"x9 5/8", #6MOR in, #6MOR out, PRV, Top Glass, Side Port with Trinary Switch	402529	ABP N83 319310
Granite	2006-12	O-Ring Type with Switch Port and HPRV	088214-00 088214-03	ABP N83 319395
MH, MH Ultraliner	1983-03	O-Ring type with female switch port & moisture indicator	221RD312 333	ABP N83 319633
MS Midliner	1983-02	High capacity O-Ring Type with trinary switch, side port, top glass	4379-RD547271	ABP N83 319064
MS Midliner	1985-89	O-Ring Type with Red Dot A/C	4379-RD570611	ABP N83 319211
MS Midliner, Magirus	1979-87	2 3/4"x10", #6MOR in, #6 MOR out, PRV, Top Glass, Side Port	402529 4379-RD535930	ABP N83 319514
R, RB, RD, RL, RS, RW	1977-81	with Econodine Engine	402529	ABP N83 319000
R, RL, RS, RW, U Conventional	1976-93	#6 male O-Ring, 2 3/4" x 10", binary switch	JA1120	ABP N83 319200
WL, WS, WM, Cruiselineer C.O.E.	1979-87	O-Ring Type with Side Mount L.P. Switch	210RD39303	ABP N83 319000
RELAY				
All	1983-00	Relay, Blower, Twin Temp, 12V, 10A, Socket Mount, 8 Terminal	4379-RD43700	ABP N83 320120
All	1983-97	Relay, Blower, 12V, 20A/30A, Tab Mount, 5 Terminals	2MR2014 3917-65885-C2	APB N83 320140
CS, CS Midliner	1983-97	Relay, Blower, 12V, 20A/30A, Tab Mount, 5 Terminals	7979-221568 7979-221655	APB N83 320140
CS, CS Midliner	1986-98	Relay, Blower, 12V, 20A/30A, Tab Mount, 5 Terminals	2MR1702	APB N83 320140
CS, MS Midliner	1983-97	Relay, 12V, 20A/30A, Tab Mount, 5 Terminals	2MR2014	ABP N83 320140
CS, MS Midliner, Magirus	1983-97	Relay, Blower, 12V, 20A/30A, Tab Mount, 5 Terminals	2MR2014	APB N83 320140
RESISTOR				
All	1980-97	Resistor, Blower Speed, Bakelite Back, 3 Terminal, 3 Speed	7979-220990	ABP N83 321310
CS, CS Midliner	1985-00	Resistor, Blower Speed, Bakelite Back, 3 Terminal, 3 Speed	4379-RD536470	ABP N83 321060

APPLICATIONS

MODEL	YEAR	DESCRIPTION	OEM P/N	ALLIANCE P/N
MACK				
RESISTOR				
MH Ultraliner	1981-95	Behr A/C units with 3 terminal, 4 speed resistor	3230-220276	ABP N83 321200
SWITCH				
All		Switch, Air Pressure, NC	4379-RD544750	ABP N83 322395
All		Valve, Solenoid, 12V, #6 MOR	207583 LA1225	ABP N83 308069
All		Valve, Solenoid, 12V, #6 MOR	4379-RD41880	ABP N83 308069
All	1973-86	Switch, Toggle, DPDT, ON-ON-ON, 4 Terminal	221030 4379-RD500710	ABP N83 322340
All	1977-86	A/C units with rocker blower fan switch, 5 terminal	220891 BA1260 4379-RD41512	ABP N83 322325
All	1979-04	Switch, Toggle, DPDT, ON-OFF-ON, 6 Terminal	7979-221189	ABP N83 322055
All	1980-05	Thermistor, CTC, 12V, Blower Speed Control	4379-RD647970	ABP N83 322925
All	1980-05	Thermistor, CTC, 24V, Blower Speed Control	4379-RD647971	ABP N83 322926
All	1985-93	Switch, Lever, DP4POS, OFF-ON-ON-ON, 10 Terminal	4379-RD553021	ABP N83 322060
C.O.E., Conventional		Switch, Air, Push Button, Chrome	4379-RD538274	ABP N83 322165
C.O.E., Conventional		Solenoid, 12V, Fan Clutch Air Control	4379-RD500600	ABP N83 322390
CH	1988-00	Fan Switch - Lever	4379-RD546941	ABP N83 322005
CH	1988-00	Fan Switch - Rotary	4379-RD587710	ABP N83 322425
CH	1993-04	Switch, Micro, 3 Terminal, with Arm	4379-RD54379 4379-RD5105900	ABP N83 322435
CH, CX, Vision	2000-2008	Switch, Rotary	4379-RD5105870	ABP N83 322800
CS	1978-94	Switch, Lever, 5 Terminal	4379-RD546941	ABP N83 322005
CS	1978-94	Kysor A/C units, rotary blower fan switch with resistor, 3 speed, DP3T	BA1145 2175002 2199002 220268	ABP N83 323148
CS	1986-94	Switch, Rotary, 3 Speed, Long Shaft, 5 Terminal	4379-RD536460	ABP N83 322190
CS Midliner, Magirus	1979-93	Switch, Rotary, 3 Speed, Long Shaft, 5 Terminal	3230-221-519 7979-220635 1MR2355	ABP N83 322190
CS, MS Midliner, Magirus	1979-93	Switch, Rotary, 3 Speed, Long Shaft, 5 Terminal	7979-220268	ABP N83 322190
CS, MS Midliner, Magirus	1979-93	Switch, Rotary, 3 Speed, Long Shaft, 5 Terminal	RD536460	ABP N83 322190
CS, MS Midliner, Magirus	1979-93	with Kysor A/C, Blower Switch (12 Volt Resistor Type)	4379-RD551940	ABP N83 323148
F C.O.E.	1975-81	Fan Switch (Bunk)	4379-RD537480	ABP N83 322345
F C.O.E.	1975-81	Switch, Toggle, DPDT, ON-OFF-ON, 6 Terminal	4379-RD41232	ABP N83 322055
F C.O.E.	1975-81	Switch, Thermal Safety, Heat Sensing, External	404008	ABP N83 322270
F C.O.E.	1975-81	Switch, Toggle, DPDT, ON-OFF-ON, 6 Terminal	4379-RD4123-2	ABP N83 322055
MH Ultraliner	1982-85	Switch, Rotary, 3 Speed, Long Shaft, 5 Terminal	4379-RD53646-0	ABP N83 322190
MS Midliner, Magirus	1979-04	Switch, Rotary, 3 Speed, Short Shaft, 5 Terminal	7979-220635	ABP N83 322150
MS Midliner, Magirus	1979-93	Switch, Rotary, 3 Speed, Long Shaft, 5 Terminal	3230-221-519 1MR2355	ABP N83 322190
MS Midliner, Magirus	1979-93	with Kysor A/C, Blower Switch (12 volt resistor type)	7979-220300 4379-RD551940	ABP N83 323148
THERMOSTAT				
CH Conventional	1988-89	Fixed, 24" Probe	4379-RD5453124	ABP N83 323010
CS Midliner	1979-87	Adjustable, 48" Capillary	4379-RD412548	ABP N83 323108
CS, CS Midliner	1989-01	Fixed, 24" Probe	4379-RD442724	ABP N83 323040

APPLICATIONS

MODEL	YEAR	DESCRIPTION	OEM P/N	ALLIANCE P/N
MACK				
THERMOSTAT				
CX	1999-09	Fixed, 24" Probe	7787-650163 4379-RD442724	ABP N83 323040
DM, DMM	1976-89	All models with Kysor Mini Brute A/C and factory air with rotary switch	7979-404075 4379-RD549090	ABP N83 323088
F C.O.E.	1975-81	Adjustable, 36" Probe	7979-404028	ABP N83 323118
MC	1985-00	Fixed, 24" Probe	RD 5 4531 24	ABP N83 323010
MH, MH Ultraliner	1982-87	Cable controlled thermostat, 43" capillary tube	3230-22533 4379-RD549170	ABP N83 323024
MH, MH Ultraliner	1982-88	Variable, Cable Controlled, 30" Capillary	4379-RD42260	ABP N83 323014
MS Midliner	1987-04	Fixed, 24" Probe	A22-23640-000	ABP N83 323010
WL, WS, Cruiselineer	1975-80	Adjustable, 36" Probe	2790-HV27072	ABP N83 323118
WATER VALVE				
All		Cable Controlled, 5/8" Hose, STR-STR, Pull to Open	2790-HV22563	ABP N83 324050
All		Cable Controlled, 5/8" Hose, STR-STR, Pull to Open	2790-HV30644	ABP N83 324215
All		Cable Operated, Red Dot (5/8" to 5/8"), pull to open	4379-RD553001 30RS326	ABP N83 324070
All		Air Operated (Red Dot), 5/8" to 5/8" hose	4379-RD588041	ABP N83 324420
All	1983-00	Air Controlled, 5/8" Hose, Offset	29RD29301	ABP N83 324015
MH Ultraliner	1986-93	Air Controlled, 5/8" Hose, 90°	4379-RD588040	ABP N83 324400
MR (Oscar)	2007-08	2RD570M, M2, M3 Unit	4379-RD552150	ABP N83 324120
R, DM	1980-96	Air Operated (Red Dot), 5/8" to 5/8" hose	29RD29300	ABP N83 324060
PETERBILT				
ACCUMULATOR				
325, 330, 335, 340	1999-10	Accumulator	F31-6063 18-04171	ABP N83 319072
357, 377, 378, 379, 385 Conv	1994-02	Aluminum, 3 1/2"x9 1/2", #12 FOR in, #12 FOR out	JC10800 JC1080 18-03837 700001	ABP N83 319269
357, 377, 378, 379, 385 Conventional	1994-10	Aluminum, 3 1/2"x9 1/8" Pad Fitting in, Pad Fitting out	FG2618 F31-6063 18-04171	ABP N83 319072
ACTUATOR				
All	1995-06	Electric, Rotary, 12V, 104° Travel	MA0200-01S P93CAA0200-01S	ABP N83 301269
All	1996-08	Electric, Universal, Rotary, 1 1/2"V, 4 pin Deutz Connector, 104° Max Travel	MA14400 650341BSM	ABP N83 301458
All	All	Air, Single Action	DA10100 DA1010	ABP N83 318113
All	All	Air, Single Action	DA10050 DA1005	ABP N83 318083
All	All	Air, Double Acting	DA10350 DA1035	ABP N83 318123
All	All	Air, Double Acting	DA10000 DA1000	ABP N83 318133
AIR FILTER				
387	2002-09	Filter, Cab Air	GD11800 525507BSM	ABP N83 328333
All	1998-2010	Filter, Cab Air	5X010007	ABP N83 325515

APPLICATIONS

MODEL	YEAR	DESCRIPTION	OEM P/N	ALLIANCE P/N
PETERBILT				
AIR FILTER				
Conventional, C.O.E.	2008-12	Filter, Cab Air, Fresh	FR11120 525838BSM	ABP N83 328335
BLOWER MOTOR				
320	1997-12	Motor, 12V, 1 Speed, Double 5/16" Shaft, WO/Mounting Studs	HB16100 HB1610 203080	ABP N83 301072
320, Dual Steer	1997-02	Motor, 12V, 1 Speed, Double 5/16" Shaft, WO/Mounting Studs	HB10500 HB1050 205780	ABP N83 301072
330, 335, 340, 365, 367 Conv	2005-10	Motor, 12V, CW, 1 Speed, Single 5/16" Shaft, Flange Mount	HA09830 HA0983 3X010983	ABP N83 301305
357, 377, 378, 379, 385 Conv	1994-00	Motor, 12V, CW, 1 Speed, Single 5/16" Shaft, with Mounting Studs	HA18250 HA1825 HA03010 HA0301-01S P93CAA301-01S P93CAA0300-01S	ABP N83 301101
357, 377, 378, 379, 385 Conventional	1994-00	Motor, 12V, CW, 1 Speed, Single 5/16" Shaft, with Mounting Studs	HA03010 HA0301-01S P93CAA0301-01S P93CAA0300-01S HA1825	ABP N83 301981
362 C.O.E, 372	1988-04	Motor, 12V, 1 Speed, Double 5/16" Shaft, with Mounting Studs	HB10850 HB1085	ABP N83 301082
377, 378, 379, 385, 387, 388, 389	1998-10	Motor, 12V, CW, 1 Speed, Single 5/16" Shaft, Flange Mount	3X010983 / HA0983	ABP N83 301305
379, 387 Conv	1997-01	Motor, 12V, CCW, 1 Speed, Single 5/16" Shaft, with Mounting Studs	BSM203133	ABP N83 301001
379, 387 Conv	1999-12	Motor, 12V, CW, 1 Speed, Single 5/16" Shaft, with Mounting Tabs	HA12600 BSM203139	ABP N83 301073
387	2000-10	Motor, 12V, CW, 1 Speed, Single 5/16" Shaft, with Mounting Tabs	HB17500 HB1750 203364	ABP N83 301073
387	2000-10	Motor, 12V, CW, 1 Speed, Single 5/16" Shaft, with Mounting Tabs	203363	ABP N83 301073
387,587	2000-12	Motor 12V, single speed, CCW flange mounted tabs	871218BSM 203364BSM 203142BSM	ABP N83 301028
C.O.E.	1998-05	Motor, 12V, CW, 1 Speed, Single 5/16" Shaft, Flange Mount	5X012163	ABP N83 301305
Conventional	1994-02	Motor 12V, single speed, CW or CCW, stud mount 5/16 shaft	2809-540-036 P93CAA0300-01S	ABP N83 301981
BLOWER WHEEL				
13-210 Mid Ranger	1986-95	Reversible, Double Entry	HC13500 HC1350 RD5-5656-0 260680	ABP N83 302032
13-210 Mid Ranger	1988-95	Reversible, Double Entry	HC1290 260680	ABP N83 302032
310, 320	1987-08	Reversible, Double Entry	HC10500 HC1050 589540	ABP N83 302222

APPLICATIONS

MODEL	YEAR	DESCRIPTION	OEM P/N	ALLIANCE P/N
PETERBILT				
BLOWER WHEEL				
310, 320 LCF	1986-03	Reversible, Double Entry	HC10500 HC1050 BSM302042	ABP N83 302222
310, 357, 375, 377, 378, 379	1986-97	CCW, Single Entry	HC12800 HC1280 RD3106-15	ABP N83 302041
320	1988-03	Reversible, Double Entry	HC13000 HC1300 RD3-2557-2	ABP N83 302002
330, 335, 340, 365, 367 Conventional	2005-10	CCW, Single Entry	HC16250 HC1625 HC0400-01S0 HC0400-01S P93CAB0400-01S	ABP N83 302261
357, 362, 375, 376, 377, 378, 379	1987-99	CW, Single Entry	HC13250 HC1325 RD5-5601-0	ABP N83 302061
387	2000-08	Reversible, Double Entry	HC10050 HC1005 563500	ABP N83 302222
CLUTCH ASSEMBLY				
All		12V, 1A Groove-Overhang, 125MM, 1 Wire	KA10550 KA1055 511869 511575	ABP N83 303261
All		12V, 2A Groove, 135MM, 1 Wire	KA10250 KA1025 511868 511051	ABP N83 303452
All		12V, 2A Groove, 125MM, 1 Wire	KA10250 KA1025 511868 524-19724	ABP N83 303462
All		12V, 2A Groove, 132MM, 1 Wire	6514-6210 KA1245 KA1075 6519-6010 6574-6210	ABP N83 303282
All		24V, 2A Groove, 132MM, 1 Wire	6519-6210	ABP N83 303302
All		12V, PV7 Groove, 119MM, 1 Wire	4645-9931 6512-6210	ABP N83 303207
All		12V, 2A Groove, 125MM, 2 Wire	4695-9931 4740-9931	ABP N83 303402
All		12V, PV8 Groove, 119MM, 2 Wire	4667-9931	ABP N83 303387
All		12V, 2A Groove, 125MM, 1 Wire	6560-6010 9353-6010	ABP N83 303232
All		12V, PV6 Groove, 5 3/4", 2 Wire	KA14000 KA1400 024-25244 14432	ABP N83 303167
All		12V, PV6 Groove, 5 3/4", 1 Wire	KA14100 KA1410 024-25144 14304	ABP N83 303287

APPLICATIONS

MODEL	YEAR	DESCRIPTION	OEM P/N	ALLIANCE P/N
PETERBILT				
CLUTCH ASSEMBLY				
All		12V, PV6 Groove, 5 7/8", 2 Wire	KA15350 KA1535 024-25241 14565	ABP N83 303187
All		12V, PV8 Groove, 6 1/8", 2 Wire	KA14050 KA140500 024-25247 14372	ABP N83 303123T
All		12V, 2A Groove, 6", 1 Wire	KA10400 KA1040 RD5-4972-0 18-01210 5019390CC 18-02572 024-21590	ABP N83 303082
All		12V, 2A Groove, 6", 2 Wire	KA15250 KA1525 024-25238 520556	ABP N83 303063T
COMPRESSOR				
All		7H15HD, 12V, 2A Groove, 125MM, 2 Wire, GQ Head	LF0231 F69-6001-231 4426SAN	ABP N83 304874Q
All		QP16HD, 12V, PV8 Groove, 123MM, 2 Wire, H Head	LF0211 F69-6001-211 252-1496 18-04178	ABP N83 304279Q
All		QP15HD, 12V, 1A Groove Overhang, 125MM, 1 Wire, D Head	488-45063	ABP N83 304039
All		QP15HD, 12V, 2A Groove, 135MM, 1 Wire, D Head	LE1135 103-55077 435-55077 488-45077	ABP N83 304059
All		QP15HD, 12V, 2A Groove, 135MM, 1 Wire, D Head	LE1260 103-55011 435-55011 488-45011	ABP N83 304025
All		QP15HD, 12V, 1 VAR Groove, 159MM, 1 Wire, D Head	LE1210 435-55065 488-45065	ABP N83 304015
All		QP15HD, 12V, 2A Groove, 135MM, 1 Wire, F Head, R-12	LF1005 488-25011 18-3006 K318-36-03	ABP N83 304019
All		QP16HD, 12V, PV8 Groove, 123MM, 2 Wire, H Head	LF0211 F69-6001-211 4705SAN 18-04175	ABP N83 304279Q
All		7H15HD, 12V, PV8 Groove, 119MM, 1 Wire, JDA Head	4660	ABP N83 304344
All		7H15HD, 12V, PV8 Groove, 119MM, 2 Wire, KG Head	F69-6002-214 4739SAN 18-04291	ABP N83 304394
All		5H14HD, 12V, 2A Groove, 132MM, 1 Wire, FL Head	LE1620 4664	ABP N83 304102
All		7H15HD, 12V, PV8 Groove, 119MM, 2 Wire, MDA Head	4476	ABP N83 304063

APPLICATIONS

MODEL	YEAR	DESCRIPTION	OEM P/N	ALLIANCE P/N
PETERBILT				
COMPRESSOR				
All		7H15HD, 12V, PV8 Groove, 125mm, GSA head, ear mount	F69-6003-112	ABP N83 304458
All		7H15HD, 12V, 2A Groove, 125MM, 2 Wire, GQ Head "Heavy Duty Version"	LF0231 F69-6001-231 4696SAN 1CC4696 F69-1000 18-04154	ABP N83 304661
All		7H15HD, 12V, 2A Groove, 125MM, 2 Wire, GQ Head	LF0231 F69-6001-231 4696SAN 1CC4696 F69-1000 18-04154	ABP N83 304661
All		7H15HD, 12V, PV8 Groove, 119MM, 1 Wire, JDA Head	4645SAN LE1150 18-03788 F69-6002-243 4645	ABP N83 304953
All		7H15HD, 12V, PV8 Groove, 119MM, 2 Wire, KC Head, Direct Mount	LE1085 4667SAN K318-103 F69-6002-114	ABP N83 304973
All		5H14HD, 12V, 2A Groove, 132MM, 1 Wire, FL Head	LE1620 4644 18-03787	ABP N83 304102
All		7H15HD, 12V, 2A Groove, 125MM, 2 Wire, GQ Head	LF0231 F69-6001-231 4426SAN	ABP N83 304661
All		7H15HD, 12V, 2A Groove, 125MM, 1 Wire, JDA Head	LE1640 18-04088 4713SAN	ABP N83 304173
All		7H15HD, 12V, 2A Groove, 132MM, 2 Wire, JDA Head, Direct Mount	4695SAN F69-1002 F69-6002-133	ABP N83 304095
All		7H15HD, 12V, PV8 Groove, 119MM, 2 Wire, MDA Head	4734 22-47692-000	ABP N83 304063
All		7H15HD, 12V, 2A Groove, 125MM, 2 Wire, JDA Head, Direct Mount	4433SAN 4740SAN 18-04373 F69-6001-233 18-04088 18-04373	ABP N83 304173
All		7H15HD, 12V, PV6 Groove, 125MM, 2 Wire, GSA Head, Direct Mount	4039 4424 4731 F69-6003-122 18-05000	ABP N83 304163
All		7H15HD, 12V, PV6 Groove, 125MM, 2 Wire, GQ Head, Direct Mount "Heavy Duty"	4040 4425 4792 F69-6002-121 F69-6000	ABP N83 304481

APPLICATIONS

MODEL	YEAR	DESCRIPTION	OEM P/N	ALLIANCE P/N
PETERBILT				
COMPRESSOR				
All		QP7H15S, 12V, PV6 Groove, 125MM, 2 Wire, GQ Head, Direct Mount "Super Duty "	F69-6003-121	ABP N83 304993Q
All		7H15HD, 12V, PV6 Groove, 125MM, 2 Wire, GQ Head, Direct Mount "Standard Duty"	F69-6001-121 1027U3	ABP N83 304894
All		7H15HD, 12V, PV6 Groove, 125MM, 1 Wire, CBA Head, Direct Mount	4687 22-44462-000	ABP N83 304053
All		7H15HD, 12V, 2A Groove, 132MM, 2 Wire, JDA Head, Direct Mount	4626SAN F69-6001-153 4626 4695 LE1140 1CC4696 F69-1000	ABP N83 304095
All		7H15HD, 12V, PV8 Groove, 119MM, 2 Wire, GQ Head, Direct Mount "Heavy Duty"	LF0111 F69-6002-111 4432SAN 4759	ABP N83 304741
All		QP7H15S, 12V, PV8 Groove, 119MM, 2 Wire, GQ Head, Direct Mount "Super Heavy Duty"	F69-6003-111 4759	ABP N83 304324Q
All		QP15, 12V, PV8 Groove, 119MM, 2 Wire, GQ Head, Direct Mount "Standard Duty"	F69-6001-111 4759	ABP N83 304884Q
All		Tube-O, LH Suction, 1"-14 Discharge, 1"-14 Suction, 12V, 2A Groove, 6", 2 Wire	LC2120 ET210L-25237C	ABP N83 304141T
All		Tube-O, LH Suction, 1"-14 Discharge, 1"-14 Suction, 12V, 2A Groove, 6", 2 Wire	LC2125 ET210L-25246C	ABP N83 304201T
All		7H15HD, 12V, PV8 Groove, 119MM, 1 Wire, MDA Head	4672SAN F69-6001-215	ABP N83 304873
All		Rotolock, LH Suction, #8 Discharge, #10 Suction, NO CLUTCH	LC2000 LC1000 LC1005 LD1000 ER210L-25149	ABP N83 304171
All		QP7H15S PV12, 126MM, GQ Head, Direct Mount "Super Duty"	F69-6003-151	ABP N83 304199Q
All		QP15 12V, PV6, 126MM, GSA Head, Direct Mount "Standard Duty"	F69-6001-122	ABP N83 304904Q
All		QP7H15S 12V, PV6, 126MM, GSA Head, Direct Mount "Super Heavy Duty"	F69-6003-122 4079 4379	ABP N83 304764Q
All		QP15, 12V, 2A Groove, 125MM, 2 Wire, GQ Head "Standard Duty Version"	LF0231 F69-6001-231 4696SAN 1CC4696 F69-1000 18-04154	ABP N83 304661Q
All		Tube-O, LH Suction, 1"-14 Discharge, 1"-14 Suction, NO CLUTCH	LC2100 LD1005 LC1010 LC1130 LC2120 ET210L-25150	ABP N83 304031
All	1995-02	Tube-O, LH Suction, 1"-14 Discharge, 1"-14 Suction, 12V, 2A Groove, 6", 1 Wire	LC1140 ET210L-25073C	ABP N83 304101T

APPLICATIONS

MODEL	YEAR	DESCRIPTION	OEM P/N	ALLIANCE P/N
PETERBILT				
CONDENSER				
289, 330, 349, 353,357,359, 375, 376, 377, 378, 379, 387	2004-08	Radiator Mount, with Pad Fittings	F31-6043 1E6043	ABP N83 306042
320, 320 LCF	1988-00	Radiator Mount	18-03903 RD4-4931-0	ABP N83 306400
330	2003-09	Radiator Mount, with Pad Fittings	18-03722	ABP N83 306321
335, 340 Conventional	2006-07	Radiator Mount, with Pad Fittings	F31-6042	ABP N83 306042
357, 377, 378, 379, 385 Conv	1987-97	Radiator Mount	18-03543 23-12753 KIT	ABP N83 306305
357, 377, 378, 379, 385 Conv	1994-07	Radiator Mount	18-04015 18-03809	ABP N83 306420
365, 367, 387, 587	2008-2012	Radiator Mount	N4778001 RO440001	ABP N83 306380
377, 378, 379, 385, 386, 387, 388, 389	2001-04	Radiator Mount	F31-6097 3S011268 18-04454	ABP N83 306041
377, 378, 379, 385, 386, 387, 388, 389 Conv	1999-04	Radiator Mount	1E4582	ABP N83 306322
386	2008-10	Radiator Mount	R0337001	ABP N83 306332
EVAPORATOR				
362 C.O.E.	1988-02	Evaporator Coil	NB10050 NB1005	ABP N83 307045
FAN				
All	All	Fan, Defrost, Universal, 12 Volt, 2 Speed	HD1130 HG1040 PB2-14 2899-006-026 038 051	ABP N83 309141
All	All	Fan, Defrost, Universal, 24 Volt, 2 Speed	HD10250 HD1025 2899-006-056	ABP N83 309013
HEATER CORE				
320	1988-03	Heater Core	MC11000 MC1100	ABP N83 315170
362, 372 C.O.E.	1981-02	Heater Core	MC11000 MC1100	ABP N83 315245
ORIFICE TUBE				
357, 377, 378, 379, 385 Conv	1994-09	Orifice Tube- Red	EC10150 EC1015 EC2500-01S P93CAB2500-01S	ABP N83 308017
357, 377, 378, 379, 385 Conventional	1998-05	Orifice Tube-Orange	EC10250 EC1025 EC010061 5X010061	ABP N83 308027
PRESSURE SWITCH				
330, 335, 340, 349, 352, 353, 357, 359, 362, 365, 367, 372, 372 C.O.E., 375, 376, 377, 378, 379, 385, 386, 387	1993-10	Switch, Pressure, Low, NO	18-03836 P93CAA3606-01	ABP N83 318160

APPLICATIONS

MODEL	YEAR	DESCRIPTION	OEM P/N	ALLIANCE P/N
PETERBILT				
PRESSURE SWITCH				
330, 357, 375, 377, 378, 379, 385 Conv	1994-10	Switch, Pressure, High, NC	18-03835 P93CAA3605-01 650697BSM	ABP N83 318170
357, 375, 376, 377, 378, 379 Conventional	1986-00	Switch, Air Pressure, NC	BA12250 BA1225 RD5-4475-0	ABP N83 322395
357, 375, 376, 377, 378, 379 Conventional	1986-00	Switch, Air Pressure, NO	BB10100 BB1010 RD5-5538-0	ABP N83 318013
357, 375, 377, 378, 379 Conventional	1988-95	Switch, Pressure, High, NO	18-03600 20PS40-11 BOA 80-942-01-695	ABP N83 318060
357, 375, 377, 378, 379 Conventional	1988-96	Switch, Pressure, Low, NO	BB10050 BB1005 20PS39-10 18-03285	ABP N83 318084
357, 375, 377, 378, 379, 385 Conventional	1994-10	Switch, Pressure, Low, NO	18-04331 18-03834 P93CAA3604-01	ABP N83 318184
362, 372, 375, 376, 377, 378, 379	1988-97	Switch, Pressure, Low, NO	BB10000 BB1000 71R6050 2299005 404097	ABP N83 318014
All	1977-00	Switch, Pressure, High, NO	BA12500 BA1250 RD5-6394-0 18-03163	ABP N83 318040
All	All	Switch, Pressure, Trinary, NO	BC10050 BC1005 RD5-4585-0	ABP N83 318009
All	All	Switch, Pressure, Trinary, NO	BC10000 BC1000 BSM865700	ABP N83 318149
All	All	Switch, Pressure, Trinary, NC	BA12400 BA1240 RD-5-4625-0	ABP N83 322200
All	All	Switch, Pressure, High, NO	18-03601 20PS39-16	ABP N83 318070
RECEIVER DRIER				
320	1987-96	Block, #6 #10 #8 #8, with Mounting Holes	EA10650 EA1065 RD5-6868-0	ABP N83 308011
320	1997-07	Block, #6 #10 #8 #10, with Mounting Holes	EA10660 EA13150 EA1315 540035	ABP N83 308071
325, 330, 335, 340	2010-12	Drier with PAD mount fittings	F37-6002 F37-6013	ABP N83 319161
357, 377, 378, 379, 385 Conventional	1994-02	Right Angle, O Ring, with Capillary	BH3804-02S P93CAC3804-02S EA3900-02S P93CAC3900-02S P93CAC3900-01S	ABP N83 308331

APPLICATIONS

MODEL	YEAR	DESCRIPTION	OEM P/N	ALLIANCE P/N
PETERBILT				
RECEIVER DRIER				
362, 372 C.O.E.	1988-04	3"x8 1/2", #6 MOR in, #6 MOR out, PRV, Side Glass, Top Port	JA10850 JA1085 088248 18-01800	ABP N83 319110
365, 367	2009-11	Drier with PAD mount fittings	F37-6009 F37-6011	ABP N83 319156
379	1999-07	Block, #6 #10 #8 #8, Flange Mount, with M10 & M12 Schrader	540057 F90-6001	ABP N83 308141
382, 385, 386, 387, 388, 389	2009-11	Drier with PAD mount fittings	F37-6008 F37-6010	ABP N83 319157
387	1999-11	Block, #6 #10 #8 #8, Flange Mount	540056	ABP N83 308151
387	2000-10	3"x10 1/16", Slimline Manifold Block	JA22250 JA2225 F37-6000	ABP N83 319575
387	2007-11	Block, #6 #10 #8 #8, Flange Mount, with M10 & M12 Schrader	549708 540057BSM F90-6001	ABP N83 308141
587	2011-12	Expansion Valve sleeper w/ flange type	540056BSM	ABP N83 308301
All	1999-05	Sleeper Unit	540044BSM	ABP N83 308261
All	2009-11	3"x10 1/16", Slimline Manifold Block	F37-6008 F37-6009	ABP N83 319157
All	2009-12	Main Unit M10, M12 ports block type	549708BSM	ABP N83 308141
Conventional, C.O.E.	1993-97	3"X8 1/4", #6 MOR in, #6 FOR out, PRV, Top Glass, Moisture ind, 1/4" Top Switch Port (2)	JA2145 088301-00 18-03783	ABP N83 319255
RELAY				
320	1997-12	Relay, Blower, 12V, 20A/30A, Tab Mount, 5 Terminals	CB11150 CB1115 CB10050 CB1005 652420	APB N83 320290
All	1986-10	Relay, Blower, 24V, 20A/30A, Tab Mount, 5 Terminal	650690	ABP N83 320280
All	1986-10	Relay, Blower, 12V, 30A/40A, Socket Mount	650731	APB N83 320140
All	1986-10	Relay, Blower, 12V, 20A/30A, Tab Mount, 5 Terminals	CB11150 CB1115 652420	APB N83 320140
RESISTOR				
320	1973-96	Resistor, Blower Speed, Bakelite Back, 3 Terminal, 3 Speed	CA1005 CA1010	ABP N83 321310
320	1987-96	Resistor, Blower Speed, Bakelite Back, 3 Terminal, 3 Speed	CA1005 650790 CA1000	ABP N83 321060
357, 377, 378, 379 Conventional	1988-96	Resistor, Blower, Potentiometer, Sliding Lever	CA10250 CA1025 RD6-4661-1	ABP N83 321090
All	1973-96	Resistor, Blower Speed, Bakelite Back, 3 Terminal, 3 Speed	CA1005 220990	ABP N83 321060
All	1987-00	Resistor, Blower Speed, Bakelite Back, 3 Terminal, 3 Speed	CA10000 CA1000 RD5-3647-0	ABP N83 321060
All	1991-96	Resistor, Blower Speed, Bakelite Back, 3 Terminal, 3 Speed	CA10350 CA1035	ABP N83 321300

APPLICATIONS

MODEL	YEAR	DESCRIPTION	OEM P/N	ALLIANCE P/N
PETERBILT				
RESISTOR				
All	1995-09	Resistor, Blower Speed, Bakelite Back, 3 Terminal, 3 Speed	CA10350 CA1035 650179	ABP N83 321300
SWITCH				
330, 335, 340, 349, 352, 353, 357, 359, 362, 365, 367, 372, 372 C.O.E., 375, 376, 377, 378, 379, 385, 386, 387	1993-05	Circuit Breaker, 15A, Push Button Reset	CC10150 CC1015 K1110-0548-15	ABP N83 320050
330, 335, 340, 349, 352, 353, 357, 359, 362, 365, 367, 372, 372 C.O.E., 375, 376, 377, 378, 379, 385, 386, 387	1993-05	Circuit Breaker, 20A, Push Button Reset	K1110-0548-20	ABP N83 320052
330, 335, 340, 349, 352, 353, 357, 359, 362, 365, 367, 372, 372 C.O.E., 375, 376, 377, 378, 379, 385, 386, 387	1993-05	Circuit Breaker, 30A, Push Button Reset	CC10200 CC1020 K1110-0552-30	ABP N83 320060
330, 335, 340, 349, 352, 353, 357, 359, 362, 365, 367, 372, 372 C.O.E., 375, 376, 377, 378, 379, 385, 386, 387	1993-05	Switch, Micro, 2 Terminal, with Arm	BA10800 BA1080 BOA-80-908-00-219	ABP N83 320220
All		Switch, Air, Toggle, Push-Lock	BA16300 BA1630 RD5-5721-1	ABP N83 322095
All		Switch, Air, Toggle, NPT	BA13550 BA1355 MA1265 RD5-3827-6	ABP N83 322195
All		Switch, Air, Toggle, Push Lock	BA14500 BA1450 BA1210 08-02445 RD5-5721-0	ABP N83 322090
All	1976-01	Switch, Air, Push Button, Chrome, NPT	BA12350 BA1235 RD5-3827-4	ABP N83 322165
All	1976-95	Switch, Micro, 2 Terminal, with Arm	BA10800 BA1080 BA1045 RD5-8490-0 652100	ABP N83 320220
All	All	Switch, Rotary, 3 Speed, Short Shaft, 5 Terminal	BA1020 BA1190 BA1390 BOA-80-926-00-059 101019Q	ABP N83 322150
Conventional	1976-01	Valve, Solenoid, 12V, #6 MOR	CD10000 CD1000 RD4188-0	ABP N83 308069
Conventional, 377, 378, 379, 385, 387, 388, 389		Fan Override Switch (Orange Body) 2 pin	BSM650469	ABP N83 322681

APPLICATIONS

MODEL	YEAR	DESCRIPTION	OEM P/N	ALLIANCE P/N
PETERBILT				
THERMOSTAT				
320	1987-11	Fixed, 24" Probe	BD11050 BD1105 589490 BD10750 BD1075	ABP N83 323010
362	1988-04	Fixed, 24" Probe	BD11050 BD1105 RD5-4531-24	ABP N83 323010
375, 376, 377, 378, 379	1987-00	Fixed, 24" Probe	BD11050 BD1105 404145	ABP N83 323010
387	1999-10	Fixed, 12" Probe	BD13550 BD1355 650163BSM	ABP N83 323050
Conventional	1995-99	Fixed, 24" Probe	P93CAA4230-02S	ABP N83 323010
Conventional, C.O.E.	1987-00	Fixed, 24" Probe	323010BSM BD11050 BD1105 BD1095 RD5-4531-24 1-4183Q	ABP N83 323010
WATER VALVE				
320	1987-96	Cable Controlled, 5/8" Hose, STR-Core, Pull to Close	MA11100 MA1110 867405	ABP N83 324555
357, 375, 377, 378, 379 Conventional	1987-00	Cable Controlled, 5/8" Hose, STR-90°, Pull to Close	MA12050 MA1205 RD5-5495-0	ABP N83 324030
357, 375, 377, 378, 379 Conventional	1987-00	Air Controlled, 5/8" Hose, Offset	MA10850 MA1085 RD5-5138-0	ABP N83 324060
362	All	Cable Controlled, 5/8" Hose, STR-STR, Pull to Close	MA11000 MA1100 RD5-5300-0	ABP N83 324080
All	1983-00	Cable Controlled, 5/8" Hose, Offset, Pull to Close	MA10100 MA1010	ABP N83 324550
Conventional, C.O.E.	1982-02	Cable Controlled, 5/8" Hose, Offset, Pull to Open	MA11650 MA1165 173096	ABP N83 324430
STERLING				
ACCUMULATOR				
A-Line, Acterra	2000-10	Accumulator with 134A charge port and pressure switch port, inlet 5/8" (#10), outlet 3/4" (#12)	4C4H19C808-AA	ABP N83 319309
A-Line, Acterra, L-Line, 5500 - 8500, Silverstar	1997-06	Accumulator with 134A charge port and pressure switch port, inlet 5/8" (#10), outlet 3/4" (#12)	F6HZ-19C836A XC4H-19E647AA	ABP N83 319309
BLOWER MOTOR				
A-Line, Acterra, L-Line, 5500 - 8500, Silverstar	1998-00	Flange motor	F1HZ19805	ABP N83 301215
A-Line, Acterra, L-Line, 5500 - 8500, Silverstar	1998-10	A/C and heater flange mounted motor, CW, vented, shaft length 1 5/8"	F6UZ-19805BA F8HH-19805AA F8HZ-19805AA BA X4CZ-19805BA	ABP N83 301020
A-Line, Acterra, L-Line, 5500 - 8500, Silverstar	1998-10	A/C and heater 7 7/8" flange motor, CW, vented, shaft length 1 1/2"	XC4H-19805-AA	ABP N83 301135

MODEL	YEAR	DESCRIPTION	OEM P/N	ALLIANCE P/N
STERLING				
CLUTCH ASSEMBLY				
A-Line, Acterra, L-Line, 5500 - 8500, Silverstar		Poly 8 groove, 4.7" diameter (119mm), Ford plug	4427-9931 7731-9930	ABP N83 303157
COMPRESSOR				
A-Line, Acterra, L-Line, 5500 - 8500, Silverstar		7H15, WJ head, direct mount, poly 6, 4.9"(125mm) diameter	4423	ABP N83 304444
A-Line, Acterra, L-Line, 5500 - 8500, Silverstar		7H15, WH head, direct mount, poly 8 groove, 4.7"(119mm) diameter	4422	ABP N83 304434
A-Line, Acterra, L-Line, 5500 - 8500, Silverstar		7H15, WJ head, ear mount, 2A groove, 5 ¼" (132mm) diameter	4469 4603 F4HT-19D629-CA	ABP N83 304474
A-Line, Acterra, L-Line, 5500 - 8500, Silverstar	1997-03	7H15, GV head, ear mount, poly 8 groove, 4.7"(119mm) diameter	4482 4885	ABP N83 304113
A-Line, Acterra, L-Line, 5500 - 8500, Silverstar	1997-03	7H15, GV head, ear mount, poly 8 groove, 4.7"(119mm) diameter	4817	ABP N83 304113
A-Line, Acterra, L-Line, 5500 - 8500, Silverstar	1997-04	7H15, WJ head, direct mount, poly 6, 4.9"(125mm) diameter	4810	ABP N83 304183
A-Line, Acterra, L-Line, 5500 - 8500, Silverstar	1997-06	7H15, WJ head, ear mount, poly 8 groove, 4.7"(119mm) diameter	4305	ABP N83 304454
A-Line, Acterra, L-Line, 5500 - 8500, Silverstar	1997-06	7H15, WJ head, ear mount, poly 8 groove, 4.7"(119mm) diameter	4427 4718	ABP N83 304753
A-Line, Acterra, L-Line, 5500 - 8500, Silverstar	1997-06	7H15, WH head, direct mount, 1A groove 6 ½" (169mm) diameter	4470 4602 F4HT-19D629-BA	ABP N83 304464
A-Line, Acterra, L-Line, 5500 - 8500, Silverstar	1997-06	7H15, WH head, direct mount, poly 8 groove, 4.7"(119mm) diameter	4486 4767 A22-48973-000	ABP N83 304434
A-Line, Acterra, L-Line, 5500 - 8500, Silverstar	1997-06	7H15, WH head, direct mount, poly 8 groove, 4.7"(119mm) diameter	4486 4767	ABP N83 304434
A-Line, Acterra, L-Line, 5500 - 8500, Silverstar	1998-02	TCCl, Tube-O, LH Suction, 1"-14 Discharge, 1"-14 Suction, NO CLUTCH	F7HS-19D629AA ET210L-25150 C	ABP N83 304031
A-Line, Acterra, L-Line, 5500 - 8500, Silverstar	1998-05	7H15, WH head, direct mount, poly 8 groove, 4.7"(119mm) diameter	7804 F4HT-19D629-AA	ABP N83 304773
CONDENSER				
A-Line, Acterra, L-Line, 5500 - 8500, Silverstar	1995-98	All models with Factory Air, Grill denser Type 37" x 19" x ¾"	F6HT-19710-BA	ABP N83 306860
A-Line, Acterra, L-Line, 5500 - 8500, Silverstar	1998-03	All models with Factory Air, Grill denser Type 37" x 19" x ¾"	F6HZ-19712A	ABP N83 306860
A-Line, Acterra, L-Line, 5500 - 8500, Silverstar	1994-97	All models with Factory Air, Grill denser Type 27" x 21" x 1"	F4HZ-19712A	ABP N83 306875
ORIFICE TUBE				
A-Line, Acterra, L-Line, 5500 - 8500, Silverstar	1994-01	Orifice Tube-Red	E59H-19860AA E69Z-19D990A	ABP N83 308017
PRESSURE SWITCH				
A-Line, Acterra, L-Line, 5500 - 8500, Silverstar		Pressure Cycling Switch, closes 46 psi	E35H-19E561A	ABP N83 318174
A-Line, Acterra, L-Line, 5500 - 8500, Silverstar		Switch, Pressure, High, NO	18-03601 20PS39-16	ABP N83 318070
A-Line, Acterra, L-Line, 5500 - 8500, Silverstar	1998-00	Accumulator Cycling R-134A Switch, normally opens 46psi	F3AH-19E561AA F3AZ-19E561A	ABP N83 318214
A-Line, Acterra, L-Line, 5500 - 8500, Silverstar	1998-99	Accumulator Cycling Switch, closes 46 psi	E35H-19E561AA	ABP N83 318174

APPLICATIONS

MODEL	YEAR	DESCRIPTION	OEM P/N	ALLIANCE P/N
STERLING				
PRESSURE SWITCH				
A-Line, Acterra, L-Line, 5500 - 8500, Silverstar	2007-2010	High Pressure Switch, M10; 4 Terminal	06-35209-000 BOA91619	ABP N83 318035
SWITCH				
A-Line, Acterra, L-Line, 5500 - 8500, Silverstar	1998-10	Lever switch, 4 terminal, 4 position	F1HZ-19986A D5AZ-19986A	ABP N83 322113
A-Line, Acterra, L-Line, 5500 - 8500, Silverstar	1998-10	Rotary switch, 4 terminal	F4DZ-19986A	ABP N83 322093
TRIPAC				
PRESSURE SWITCH				
TRIPAC APU		SWITCH - BINARY PRESSURE (SCHRADER)	417020	
VOLVO/WHITE GMC				
BLOWER MOTOR				
ACL, WC, WCA, WG, WH, WI, WIA, WX, WXL, WXR	1988-00	Motor, 12V, 1 Speed, Double 5/16" Shaft, WO/ Mounting Studs, with Adapter Harness	3945237	ABP N83 301362
All		Motor, 12V, 1 Speed, Double 5/16" Shaft, with Mounting Studs	3918242 2809-541-006	ABP N83 301411
All		Motor, Flange Mount, 1 speed, 4 3/4" length, CW, No Wire	3949261	ABP N83 301025
All		Motor, 12V, CW, 1 Speed, Single 5/16" Shaft, with Mounting Studs	3949262 60009-5009	ABP N83 301001
All		Motor, 12V, 1 Speed, Double 5/16" Shaft, WO/Mounting Studs	3949266	ABP N83 301072
All		Motor, 12V, CW, 1 Speed, Single 5/16" Shaft, with Mounting Studs	3949388	ABP N83 301004
All		Motor, 12V, CW, 1 Speed, Single 5/16" Shaft, with Mounting Studs	1707646	ABP N83 301004
All		Motor, 12V, CCW, 1 Speed, Single 5/16" Shaft, with Mounting Studs	60009-5005 2807-517-019	ABP N83 301761
All		Kysor A/C, single shaft-non-vented, 1 speed, CW, 4 7/8" length	60009-5014 275130	ABP N83 301089
All		Motor, 12V, CW, 1 Speed, Single 5/16" Shaft, with Mounting Studs	892106	ABP N83 301101
FE	1988-02	Motor, 12V, 1 Speed, Double 5/16" Shaft, with Mounting Studs	275102	ABP N83 301172
VN, VHD, VT	1996-06	Main Behr unit motor with blower wheel	BOA-80-414-00-769 3946686	ABP N83 301274
VN, VHD, VT	2002-10	Main Unit and sleeper	BOA94350 BOAD8587	ABP N83 301304
VN420, 610, 770	1998-02	Sleeper Unit (Behr), plate mount, 7 3/16" diameter	BOA-85-462-51-009 3949886	ABP N83 301327
VN420, 610, 770, VNL64T	1996-02	Behr Sleeper Unit, plate mounted, 7" diameter, CW, 1 speed, 4 3/4" length	3949102 BOA-85-440-51-009	ABP N83 301307
VN770	1997-03	Sleeper Unit, plate mounted 7" diameter, CCW	3949886	ABP N83 301891
WC, WCA, WG, WIA	1988-00	Motor, 12V, 1 Speed, Double 5/16" Shaft, without Mounting Studs	868541	ABP N83 301322
WG, WX Dual, WXL Dual	1988-01	Main unit (Bergstrom), plate mounted 6 3/4" diameter	1092319	ABP N83 301971
WG, WXL	1988-00	Motor, 12V, 1 Speed, Double 5/16" Shaft, with Mounting Studs	V1118390 3945237	ABP N83 301332
WG, WXL	1988-00	Motor, 12V, 1 Speed, Double 5/16" Shaft, WO/ Mounting Studs, with Adapter Harness	BOA-80-415-00-159 279 3919288	ABP N83 301362

MODEL	YEAR	DESCRIPTION	OEM P/N	ALLIANCE P/N
VOLVO/WHITE GMC				
BLOWER MOTOR				
WX Dual	1988-01	Main unit, Bosch motor, plate mounted 6 3/4" diameter	203038 60009-5025 V1092319 V1119217	ABP N83 301971
BLOWER WHEEL				
ACL	1998-00	Wheel, Blower, Reversible, Double Entry	1118417	ABP N83 302222
All		Wheel, Blower, Reversible, Double Entry	260680 BSM602005	ABP N83 302032
All		Red Dot A/C with 3 5/16" double entry wheel, 3 3/4" width	3918247	ABP N83 302012
All		CCW, Single Entry	60010-5001	ABP N83 302041
All		CW, Single Entry	60010-5002 3949274	ABP N83 302111
All		CCW, Single Entry	60010-5009 1-1033Q HC1025 HC1340	ABP N83 302021
All		Reversible, Double Entry	60010-5014 HC1290	ABP N83 302032
VN420, 610	1996-06	Sleeper units, 5 5/8" single entry wheel, 3 7/16" width, CW	3947421 BSM302011	ABP N83 302011
CLUTCH ASSEMBLY				
All		1 groove, 6 3/4" diameter pulley, 1/2" width, 1 3/4" gaugeline, bullet plug	02701-0496 10582 502731 520533A	ABP N83 303071
All		2 groove 6" diameter pulley, 1/2" width, 1 5/8" ga, bullet plug	332639	ABP N83 303252
All		2 groove 6" diameter pulley, 1/2" width, 1 5/8" ga, bullet plug	61103-0019	ABP N83 303532
All		2 groove 1/2" width, 5 1/4" diameter (132mm), metripak plug	4752-9931 4777-9931 85100878	ABP N83 303492
All		2 groove 1/2" width, 5 1/4" diameter (132mm), metripak plug	3918124	ABP N83 303482
All		12V, PV8 Groove, 119MM, 2 Wire	3099389 3948140 4606-6871 4705-9930 9931	ABP N83 303387
All		12V, 2A Groove, 132MM, 1 Wire	6519-6010	ABP N83 303282
All		12V, 2A Groove, 132MM, 1 Wire	6514-6210	ABP N83 303282
All		12V, 2A Groove, 125MM, 2 Wire	85105256 4695-9931 4896-9931	ABP N83 303402
All		12V, 2A Groove, 125MM, 1 Wire	6511-6110 9353-6010	ABP N83 303232
All		12V, 1A Groove-Overhang, 125MM, 1 Wire	511575 511869	ABP N83 303261
All		12V, 2A Groove, 6", 1 Wire	1118116 61103-0017 024 21590	ABP N83 303082
All		12V, 2A Groove, 7", 1 Wire	31160-7760 332334	ABP N83 303012

APPLICATIONS

MODEL	YEAR	DESCRIPTION	OEM P/N	ALLIANCE P/N
VOLVO/WHITE GMC				
COMPRESSOR				
All		Rotolock, LH Suction, #8 Discharge, #10 Suction, NO CLUTCH	ER210L-25149	ABP N83 304171
All		Rotolock, LH Suction, #8 Discharge, #10 Suction, NO CLUTCH	99242-5	ABP N83 304171
All		Tube-O, LH Suction, 1"-14 Discharge, 1"-14 Suction, NO CLUTCH	ET210L-25150	ABP N83 304031
All		Tube-O, LH Suction, 1"-14 Discharge, 1"-14 Suction, NO CLUTCH	99244-5	ABP N83 304031
All		QP15HD, 12V, 2A Groove, 135MM, 1 Wire, D Head	488-45077	ABP N83 304059
All		QP16 2 groove 5"(125mm) ear mount, will fit Sanden 4717 applications	8082270 4717	ABP N83 304639Q
All		7H15HD, 12V, 2A Groove, 132MM, 2 Wire, JDA head, Direct Mount	8022507 4626	ABP N83 304095
All		7H15HD, 12V, 2A Groove, 125MM, 1 Wire, JD head	8164872 4627	ABP N83 304125
All		7H15, KC head, ear mount, poly 8 groove, 5 3/8" (130 mm) diameter	8142556 4659	ABP N83 304273
All		7H15, KC head, ear mount, poly 8 groove, 5 3/8" (130 mm) diameter	8142556	ABP N83 304273
All		7H15, JD head, ear mount, 2 groove, 5 3/4" diameter (132mm)	8080060 4694	ABP N83 304193
All		7H15, JD head, direct mount, 2A groove, 5 3/4" diameter (132mm)	8080059 85104467 4699	ABP N83 304524
All		7H15, JD head, direct mount, 2A groove, 5 3/4" diameter (132mm)	8080059 4699	ABP N83 304524
All		7H15, KC head, ear mount, poly 8 groove, 5 3/8" (130 mm) diameter	8080058 8142556 8177089	ABP N83 304664
All		7H15, JD head, ear mount, poly 8 groove, 4.7" (119 mm) diameter	8142556 4711 8103	ABP N83 304432
All		7H15, WV head, direct mount, 2A groove, 5 3/4" diameter (132mm)	8082269 4715	ABP N83 304213
All		7H15, WV head, ear mount, poly 8 groove, 5 3/8" (130 mm) diameter	8082268 4716	ABP N83 304534
All		7H15, WV head, ear mount, 2A groove, 5 3/4" diameter (132mm)	8082270 4717	ABP N83 304574
All		7H15, WV head, direct mount, poly 8 groove, 5 3/8" (130 mm) diameter	20388777 4733	ABP N83 304634
All		7H15, WV head, direct mount, poly 6 groove, 4.9" diameter (125 mm)	8088112 20501069	ABP N83 304624
All		7H15, WV head, ear mount, 2A groove, 5 3/4" diameter (132mm)	20370289 20501067 4777 4893	ABP N83 304574
All		7H15, WV head, ear mount, 2A groove, 5 3/4" diameter (132mm)	85104592	ABP N83 304574
All		7H15, WV head, direct mount, 2A groove, 5 3/4" diameter (132mm)	20370290 4778	ABP N83 304213
All		(125mm) Ear Mount JDA head, 2A groove clutch	20370291 4779	ABP N83 304584

MODEL	YEAR	DESCRIPTION	OEM P/N	ALLIANCE P/N
VOLVO/WHITE GMC				
CONDENSER				
All		7H15, JD head, direct mount, 2A groove, 5 1/4" diameter (132mm)	20370292 4780	ABP N83 304095
All		7H15, KC head, ear mount, poly 8 groove, 4.9" (125mm) diameter	20370293 4781	ABP N83 304273
All		7H15, KC head, direct mount, poly 8 groove, 5 1/8" (130 mm) diameter	20395054 4823	ABP N83 304253
All		7H15, WV head, direct mount, 2A groove, 5 1/4" diameter (132mm)	85104593 4890	ABP N83 304213
All		7H15, WV head, direct mount, poly 8 groove, 5 1/8" (130 mm) diameter	20501067 4892	ABP N83 304634
All		7H15, JD head, direct mount, 2A groove, 5 1/4" diameter (132mm)	8080059 85104467 4894	ABP N83 304654
All		7H15, KC head, ear mount, poly 8 groove, 5 1/8" (130 mm) diameter	85104531 4895	ABP N83 304664
All		QP15HD, 12V, 1A Groove Overhang, 125MM, 1 Wire, D Head	488-45063	ABP N83 304039
All		QP15HD, 12V, 2A Groove, 135MM, 1 Wire, D Head	488-45011	ABP N83 304025
All		QP15HD, 12V, 1 VAR Groove, 159MM, 1 Wire, D Head	488-45065	ABP N83 304015
All		QP15HD, 12V, 1A Groove Overhang, 125MM, 1 Wire, F Head, R-12	488-25063	ABP N83 304029
All		QP15HD, 12V, 2A Groove, 135MM, 1 Wire, F Head, R-12	488-25011	ABP N83 304019
All		7H15HD, 12V, 2A Groove, 125MM, 1 Wire, JDA head	8177090 4647	ABP N83 304853Q
All		7H15, JD head, ear mount, 2A groove, 4.9" (125mm) diameter	85104468 4896	ABP N83 304674
All		7H15, C head, ear mount, variable groove 6 1/4" diameter (158mm)	V1110148	ABP N83 304983
All		7H15SHD, WV head direct mount, poly 6, (125mm) diameter		ABP N83 304446
All		7H15SHD, WV head direct mount, poly 8, (128mm) diameter	20370290	ABP N83 304445
All		7H15HD, 12V, PV8 Groove, 119MM, 1 Wire, JDA head	8177089 4660	ABP N83 304344
All		5H14HD, 12V, 2A Groove, 132MM, 1 Wire, FL head	8080060 4510	ABP N83 304102
All		5H14HD, 12V, 2A Groove, 132MM, 1 Wire, FL head	8177090 6664	ABP N83 304102
All		7H15HD, 12V, 2A Groove, 125MM, 1 Wire, JD head	20370291 8164872	ABP N83 304125
All		7H15HD, 12V, 2A Groove, 132MM, 2 Wire, JDA head, Direct Mount	8022507 8177091	ABP N83 304095
CONDENSER				
All		Radiator Mount	RD-4-3724-0	ABP N83 306270
VN	1996-03	Radiator Mount, Tube-Fin Type overall 32 1/2", fin width 30 3/4" x 16 3/8"	20461065 21095290 3092918 8084347 8084348	ABP N83 306022

APPLICATIONS

MODEL	YEAR	DESCRIPTION	OEM P/N	ALLIANCE P/N
VOLVO/WHITE GMC				
EVAPORATOR				
WX, WXL Dual	1994-00	Evaporator Coil	60004-3201 NA1310 NB1100	ABP N83 307185
EXPANSION VALVE				
ACL	1988-00	Block, #6 #10 #8 #8, with Mounting Holes	3916657	ABP N83 308011
All		Main unit with internal equalizer, 1 ½ Ton, male O-Ring	A22-14420-1	ABP N83 308115
All		Right Angle, O Ring, with Capillary, with Equalizer	60012-5002	ABP N83 308085
VHD	2000-02	Block, #6 #10 #8 #10, with Mounting Holes	3916182 3949881 BOA-80-321-00-249	ABP N83 308071
VN420, 610, 770	1996-01	Block, #6 #10 #8 #8, Flange Mount	3946673 BOA-80-321-00-209	ABP N83 308151
VN420, 610, 770	1996-02	Main Unit	3946673 BOA-80-321-00-209	ABP N83 308301
WCA, WH, WG, WIA, WX	1988-01	Block, #6 #10 #8 #8, with Mounting Holes	BSM308011 3916657 540031 040138-123 EA1065	ABP N83 308011
FAN				
All		Bergstrom, Kysor and Red Dot A/C, 10" diameter, 23° pitch	60501-5002	ABP N83 309121
All		Fan, Defrost, Universal, 12 Volt, 2 Speed	4060009-000 8911949 2899-006-026 038 051	ABP N83 309141
FILTER				
VN, Conventional, C.O.E.	2003-13	Pleated air filter, 12 ½" wide x 9 ¼" high x 1 ⅝" thick	20435801	ABP N83 328217
PRESSURE SWITCH				
All		Switch, Pressure, Trinary, NC	RD-5-4625-0 BA1240	ABP N83 322200
All		Switch, Pressure, Trinary, NO	RD-5-4583-0P	ABP N83 318149
All		Switch, Pressure, Trinary, NC	RD-5-4620-0P	ABP N83 322175
All		APADS controller	20579815	ABP N83 318604
All		APADS controller	8042108 3939315	ABP N83 318648
All		APADS controller	8042133 20357741 20579810 8042157	ABP N83 318602
All		APADS controller	8042107 3939313	ABP N83 318678
All		APADS controller	8042114 3099497	ABP N83 318606
All		APADS controller	8042106 3939314	ABP N83 318610
All		Binary ¾"-24 UNF male with bulkhead seal	RD 5 4646 0	ABP N83 318079
All		ECM, APADS Controller	8042105	ABP N83 318638
All		APADS controller	8042103	ABP N83 318608
All		APAds fan trigger control switch, M10 female fitting	8040242	ABP N83 318898
All		Switch, Pressure, APADS, High, NC	8040135	ABP N83 318718

APPLICATIONS

MODEL	YEAR	DESCRIPTION	OEM P/N	ALLIANCE P/N
VOLVO/WHITE GMC				
PRESSURE SWITCH				
All		APAds low pressure switch, M10 female fitting	8040189	ABP N83 318858
All		APAds low pressure switch, ¼" NPTF fitting	8040223 3948742	ABP N83 318918
All		with Red Dot A/C, Trinary Switch with harness	61522-0007	ABP N83 318131
All		Switch, Pressure, Trinary, NO	RDH RD5 4585 0 61522-3801	ABP N83 318009
Conventional, C.O.E.		Switch, Pressure, Trinary, NC	61522-0006 176225	ABP N83 322200
RECEIVER DRIER				
ACL, WG, WX, WXLL, WXR	1999-01	O-Ring Type with moisture indicator	3934718 20407203	ABP N83 319395
All		2 ¾"x10", #6MOR in, #6 MOR out, PRV, Top Glass, Side Port	3441124 61510-5006	ABP N83 319514
All		2 ¾"x10", #6MOR in, #6MOR out, PRV, Top Glass, Side Port with Low Pressure Switch	61510-0001 7077922 BSM319000	ABP N83 319014
All		#6 male O-Ring, 2 ¾" x 10 ⅝", without trinary switch	61510-5005	ABP N83 319130
VHD	1998-10	O-Ring Type with 90° inlet and outlet	20447319 8086753	ABP N83 319395
VN420, 610, 770	1996-00	O-Ring type with female switch port, moisture indicator and 90° fittings	20407205 088492-01 8078261	ABP N83 319661
VN420, 610, 770	1996-00	O-Ring type with female switch port, moisture indicator and straight fittings	20407203	ABP N83 319633
VN420, 610, 770	1997-02	O-Ring Type with moisture indicator "Standard Version"	20447319 8086753	ABP N83 319671
VN420, 610, 770	1998-13	O-Ring Type with moisture indicator "OEM Version"	8086753 82733985	ABP N83 319671
VN420, 610, 770	1998-13	O-Ring Type with 90° inlet and outlet	088485-01 8086753	ABP N83 319395
WG, WCA, WIA	1987-03	O-Ring Type with moisture indicator	20407205 3934718 8025531 088491-01 61510-0008	ABP N83 319395
WH, WX, WX Dual, WXLL	1998-06	O-Ring Type with Switch Port and HPRV	8025531	ABP N83 319395
RELAY				
FE	1974-00	Relay, Blower, 12V, 20A/30A, Tab Mount, 5 Terminals	176569 651150	APB N83 320140
VHD, VN, 420, 610, 770	1996-01	Relay, Blower, 12V, 30A/40A, Socket Mount	BOA 80-945-00-079 3949297	APB N83 320140
VN420, 610, 770	1996-01	Relay, Blower, 12V, 30A/40A, Socket Mount	BOA-80-945-00-079	APB N83 320140
RESISTOR				
ACL, WCA, WG, WH, WIA, WX, WX Dual, WXLL, WXR	1984-00	Resistor, Blower Speed, Bakelite Back, 3 Terminal, 3 Speed	1115284	ABP N83 321300
ACL, WCA, WG, WH, WIA, WX, WX Dual, WXLL, WXR	1988-02	Resistor, Blower Speed, Bakelite Back, 3 Terminal, 3 Speed	3134241	ABP N83 321300

APPLICATIONS

MODEL	YEAR	DESCRIPTION	OEM P/N	ALLIANCE P/N
VOLVO/WHITE GMC				
RESISTOR				
ACL, WG, WH, WX, WIA, WCA, WX Dual, WXR, WXL	1984-00	Resistor, Blower Speed, Bakelite Back, 3 Terminal, 3 Speed	V1115284 V1118410 V212421 V313119 V3134241	ABP N83 321300
All		Resistor, Blower Speed, Bakelite Back, 3 Terminal, 3 Speed	60057-5005	ABP N83 321310
All	1987-05	Resistor, Blower Speed, Bakelite Back, 3 Terminal, 3 Speed	V1697520 RD-5-3647-0	ABP N83 321060
VHD, VN, 420, 610, 770	1996-06	Resistor, Blower Speed, Bakelite Back, 3 Terminal, 3 Speed	BOA-80-926-00-139 3946681	ABP N83 321300
VN420, 610	1995-06	Resistor, Blower Speed, Bakelite Back, 3 Terminal, 3 Speed	650179	ABP N83 321300
VN420, 610, 770	1997-04	Resistor, Blower Speed, Bakelite Back, 3 Terminal, 3 Speed	BOA-80-926-00-179 3949112	ABP N83 321300
SWITCH				
All	1988-00	Bergstrom A/C units, rocker, 2 terminal, 2 position, SPST	1118424 650088	ABP N83 322229
All	1993-00	Switch, Rotary, 3 Speed, Short Shaft, 5 Terminal	BA1020 BA1190 BOA-80-926-00-059	ABP N83 322150
All	All	Toggle switch, SPST, 2 terminal	60015-5015	ABP N83 322345
THERMOSTAT				
ACL	1994-02	Fixed 32" capillary tube	3915962 525335 BSM323020	ABP N83 323020
All		with Knob Type 72" Cap Tube	30-2750267	ABP N83 323238
VHD	2000-02	Fixed 18" capillary tube, 28 - 35°F	BOA-80-946-00-129 3093431	ABP N83 323120
WCA, WG, WH, WIA, WX	1988-00	Fixed 21" capillary tube, 31 - 40°F	1118408	ABP N83 323110
WATER VALVE				
WG, WXL Dual	1998-02	Cable Operated (Bergstrom), pull to open	BSM324146	ABP N83 324525
WH, WX, WXR	1999-00	Cable Operated (Bergstrom), pull to open	1118414	ABP N83 324525
WESTERN STAR				
BLOWER MOTOR				
Constellation	1993-02	Sleeper unit, single shaft, CCW, 4 1/2" length	60009-3405	ABP N83 301331
Constellation	1996-04	Main cab (Red Dot), single shaft, 1 speed, CW, 4 3/8" length	RD-3-8657-0	ABP N83 301771
Constellation	1996-99	Sleeper unit with heater blower motor, 1 speed, CW, 4" length	RD-5-9102-0	ABP N83 301097
Constellation 4800, 4900, 5800, 5900	1993-03	Sleeper Unit (Red Dot), motor blower assembly	176132 RD-3-4058-0P RD-5-6315-0	ABP N83 301279
Constellation 4800, 4900, 5900, 6900	1985-98	Motor, 12V, CCW, 1 Speed, Single 5/16" Shaft, with Mounting Studs, RFI Shielded	6009-5003	ABP N83 301121
Constellation 4800, 4900, 5900, 6900	1996-01	Motor, 12V, CW, 1 Speed, Single 5/16" Shaft, with Mounting Studs	RD-5-8663-0	ABP N83 301001
Constellation, Heritage, 3800, 4800, 4900, 5800, 5900, 6900		OE style blower motor (only), 3 3/4" length, non-vented	849601 851402 865236 3093404	ABP N83 301931

APPLICATIONS

MODEL	YEAR	DESCRIPTION	OEM P/N	ALLIANCE P/N
WESTERN STAR				
BLOWER MOTOR				
Constellation, Heritage, 3800, 4800, 4900, 5800, 5900, 6900		Motor, 12V, CCW, 1 Speed, Single 5/16" Shaft, with Mounting Studs	03-7075298	ABP N83 301191
Constellation, Heritage, 3800, 4800, 4900, 5800, 5900, 6900	1971-84	Motor, 12V, CW, 1 Speed, Single 5/16" Shaft, with Mounting Studs	02-7008314 1707686	ABP N83 301004
Constellation, Heritage, 3800, 4800, 4900, 5800, 5900, 6900	1971-84	Motor, 12V, CCW, 2 Speed, Single 5/16" Shaft, with Mounting Studs	02-7086612 60009-5005	ABP N83 301131
Heritage	1985-98	Motor, 12V, CCW, 1 Speed, Single 5/16" Shaft, with Mounting Studs	6009-5003 2807-517-019	ABP N83 301761
Heritage 3800, 4800, 4900, 5900, 6900	1983-01	Motor, 12V, CCW, 1 Speed, Single 5/16" Shaft, with Mounting Studs	3949263 RD-5-6526-1	ABP N83 301761
Heritage 3800, 4800, 4900, 5900, 6900	1985-99	Motor, 12V, CW, 1 Speed, Single 5/16" Shaft, with Mounting Studs	60009-5009	ABP N83 301001
Heritage 3800, 4800, 4900, 5900, 6900	1988-01	Motor, 12V, CW, 1 Speed, Single 5/16" Shaft, with Mounting Studs	3949262 RD-5-6526-0 RD-5-8202-0	ABP N83 301001
Heritage 4800, 4900, 5800, 5900, 6900	1984-99	Motor, 12V, CW, 1 Speed, Single 5/16" Shaft, with Mounting Studs	RD-5-6526-0 6009-5003	ABP N83 301001
Heritage 4800, 4900, 5900, 6900	1995-05	Motor, 12V, CW, 1 Speed, Single 5/16" Shaft, with Mounting Studs	RD-3-8657-0	ABP N83 301101
BLOWER WHEEL				
Constellation 3800, 4800, 4900, 5900, 6900	1984-96	CCW, Single Entry	60010-5001 RD-5-8618-0P	ABP N83 302041
Constellation 4800, 4900, 5800, 5900	1983-00	Main unit, single entry wheel (plastic), CW, 5 1/4" diame	02-7073625	ABP N83 302241
Constellation 4800, 4900, 5800, 5900	1985-98	CW, Single Entry	60010-4401 RD-5-3800-1P	ABP N83 302111
Constellation 4800, 4900, 5800, 5900	1995-01	CW, Single Entry	60012-5001 RD-5-5601-0	ABP N83 302061
Constellation, Heritage, 3800, 4800, 4900, 5800, 5900, 6900		CCW, Single Entry	RD-5-8618-0P RD-3106-9P	ABP N83 302041
Heritage 3800, 4800, 4900, 5900, 6900	1985-98	CW, Single Entry	60010-4401	ABP N83 302051
Heritage 3800, 4800, 4900, 5900, 6900	1988-01	CW, Single Entry	3949274 RD-3106-15 RD-5-3800-1	ABP N83 302111
CLUTCH ASSEMBLY				
Constellation, Heritage, 3800, 4800, 4900, 5800, 5900, 6900		1 groove, 6 3/4" diameter pulley, 1/2" width, 1 3/4" gaugeline, bullet plug	02-7010496 L50-2731 502731	ABP N83 303071
Constellation, Heritage, 3800, 4800, 4900, 5800, 5900, 6900		Poly 8 groove, 4.9" 125mm dia groove	6593-6010 6522-6010	ABP N83 303157
Constellation, Heritage, 3800, 4800, 4900, 5800, 5900, 6900		12V, 2A Groove, 132MM, 1 Wire	509285 6575-6310	ABP N83 303282
Constellation, Heritage, 3800, 4800, 4900, 5800, 5900, 6900		12V, 1A Groove-Overhang, 125MM, 1 Wire	511575 511869	ABP N83 303261

APPLICATIONS

MODEL	YEAR	DESCRIPTION	OEM P/N	ALLIANCE P/N
WESTERN STAR				
CLUTCH ASSEMBLY				
Constellation, Heritage, 3800, 4800, 4900, 5800, 5900, 6900		12V, 2A Groove, 125MM, 1 Wire	511051 624-19749	ABP N83 303462
Constellation, Heritage, 3800, 4800, 4900, 5800, 5900, 6900		12V, 2A Groove, 6", 2 Wire	024 25238 30932420 520566 522582	ABP N83 303063T
Constellation, Heritage, 3800, 4800, 4900, 5800, 5900, 6900		12V, 2A Groove, 7", 1 Wire	02-7074272 332334 MA 7A	ABP N83 303012
COMPRESSOR				
Constellation, Heritage, 3800, 4800, 4900, 5800, 5900, 6900		Tube-O, LH Suction, 1"-14 Discharge, 1"- 14 Suction, 12V, 2A Groove, 6", 2 Wire	ET210L-25237C	ABP N83 304141T
Constellation, Heritage, 3800, 4800, 4900, 5800, 5900, 6900		Tube-O, LH Suction, 1"-14 Discharge, 1"- 14 Suction, 12V, 2A Groove, 6", 2 Wire	ET210L-25246C	ABP N83 304201T
Constellation, Heritage, 3800, 4800, 4900, 5800, 5900, 6900		Tube-O, LH Suction, 1"-14 Discharge, 1"- 14 Suction, 12V, 2A Groove, 6", 1 Wire	ET210L-25073C	ABP N83 304101T
Constellation, Heritage, 3800, 4800, 4900, 5800, 5900, 6900		QP15HD, 12V, 1A Groove Overhang, 125MM, 1 Wire, D Head	488-45063	ABP N83 304039
Constellation, Heritage, 3800, 4800, 4900, 5800, 5900, 6900		QP15HD, 12V, 2A Groove, 135MM, 1 Wire, D Head	488-45011	ABP N83 304025
Constellation, Heritage, 3800, 4800, 4900, 5800, 5900, 6900		QP15HD, 12V, 1 VAR Groove, 159MM, 1 Wire, D Head	488-45065	ABP N83 304015
Constellation, Heritage, 3800, 4800, 4900, 5800, 5900, 6900		QP15HD, 12V, 2A Groove, 135MM, 1 Wire, F Head, R-12	488-25011	ABP N83 304019
Constellation, Heritage, 3800, 4800, 4900, 5800, 5900, 6900		7H15HD, 12V, PV8 Groove, 119MM, 1 Wire, JDA Head	4645 4665 61104-3423 85100887	ABP N83 304953
Constellation, Heritage, 3800, 4800, 4900, 5800, 5900, 6900		7H15, 12V, PV8 Groove, 119MM, 2 Wire, KC Head, Direct Mount	61104-3430 4667 4897	ABP N83 304973
Constellation, Heritage, 3800, 4800, 4900, 5800, 5900, 6900		7H15HD, 12V, 2A Groove, 125MM, 1 Wire, JD Head	61104-3411 3916160	ABP N83 304125
Constellation, Heritage, 3800, 4800, 4900, 5800, 5900, 6900		Rotolock, LH Suction, #8 Discharge, #10 Suction, NO CLUTCH	ER210L-25149	ABP N83 304171
Constellation, Heritage, 3800, 4800, 4900, 5800, 5900, 6900		Rotolock, LH Suction, #8 Discharge, #10 Suction, NO CLUTCH	99242-5	ABP N83 304171
Constellation, Heritage, 3800, 4800, 4900, 5800, 5900, 6900		Tube-O, LH Suction, 1"-14 Discharge, 1"-14 Suction, NO CLUTCH	ET210L-25150	ABP N83 304031
Constellation, Heritage, 3800, 4800, 4900, 5800, 5900, 6900		Tube-O, LH Suction, 1"-14 Discharge, 1"-14 Suction, NO CLUTCH	99244-5	ABP N83 304031

APPLICATIONS

MODEL	YEAR	DESCRIPTION	OEM P/N	ALLIANCE P/N
WESTERN STAR				
COMPRESSOR				
Constellation, Heritage, 3800, 4800, 4900, 5800, 5900, 6900		QP15HD, 12V, 2A Groove, 135MM, 1 Wire, D Head	488-45077	ABP N83 304059
Constellation, Heritage, 3800, 4800, 4900, 5800, 5900, 6900		7H15HD, 12V, 2A Groove, 125MM, 1 Wire, JD Head	4627 8164872	ABP N83 304125
Constellation, Heritage, 3800, 4800, 4900, 5800, 5900, 6900		7H15, KCA head, direct mt, poly 8, 4.7" (119mm) diameter	61104-3430 4666 4897	ABP N83 304263
Constellation, Heritage, 3800, 4800, 4900, 5800, 5900, 6900		7H15, JD Head, direct mount, 2A groove, 5 1/4" diameter (132mm)	20370292 4780	ABP N83 304095
Constellation, Heritage, 3800, 4800, 4900, 5800, 5900, 6900	1993-03	7H15HD, 12V, 2A Groove, 132MM, 2 Wire, JDA Head, Direct Mount	61104-3420 20370292 4626	ABP N83 304095
Constellation, Heritage, 3800, 4800, 4900, 5800, 5900, 6900	2010-14	Nippondenso 12v, PV8 groove 140mm dia direct mount	10S15C 22-65770-000	ABP N83 304914
Constellation, Heritage, 3800, 4800, 4900, 5800, 5900, 6900	2011-14	Nippondenso PV8 159mm dia direct mount	10S15C 22-65771-000	ABP N83 304915
CONDENSER				
604	1994-2006	Grilldenser Type overall 39 3/8", fin width 35 1/2" x 22 5/8"	61203-3409	WWS RD-4-5273-0
Constellation, Heritage, 3800, 4800, 4900, 5800, 5900, 6900	1986-92	Serpentine Type overall 29 3/4", fin width 27 1/8" x 15 3/4"	61203-3209	ABP N83 306240
Constellation, Heritage, 3800, 4800, 4900, 5800, 5900, 6900	1994-04	Condenser Coil	61203-3428	WWS RD-4-5287-0
Constellation, Heritage, 3800, 4800, 4900, 5800, 5900, 6900	2008-12	34.5" x 22" x 3/4"	22-66839 RDH4 7131 0	ABP N83 306032
EVAPORATOR				
Constellation	1993-04	Main unit (Red Dot R-5260), 8" high x 5 5/8" long x 2 1/2" wide	60004-3401	ABP N83 307560
Constellation	1993-09	Sleeper unit (Red Dot R-4230), 8 1/8" x 7 7/8" x 3 1/2"	60004-3402	ABP N83 307480
Constellation	2004-08	Main unit (Red Dot R-5275)		ABP N83 307715
Heritage 3800, 4800, 4900, 5800, 5900, 6900	1983-08	Evaporator Coil	176167 6004-4403	ABP N83 307110
Heritage 3800, 4800, 4900, 5900, 6900	1988-01	Main unit	176169 6004-4401	ABP N83 307200
EXPANSION VALVE				
Constellation 3800, 4800, 4900, 5800, 5900, 6900	1988-08	Block, #6 #10 #8 #8, with Mounting Holes	3916657 60012-4401 60012-5001	ABP N83 308011
Constellation 4800, 4900, 5800, 5900, 6900	1993-07	Block, #6 #10 #8 #10, with Mounting Holes	RD-5-7015-0	ABP N83 308071
Constellation, Heritage, 3800, 4800, 4900, 5800, 5900, 6900		Right Angle, Flare, with Capillary, with Equalizer	02-7010501 02-7086617 2684701-C1	ABP N83 308015
Constellation, Heritage, 3800, 4800, 4900, 5800, 5900, 6900		Right Angle, O Ring, with Capillary, with Equalizer	02-7086505 RD-5-3824-1	ABP N83 308085

APPLICATIONS

MODEL	YEAR	DESCRIPTION	OEM P/N	ALLIANCE P/N
WESTERN STAR				
EXPANSION VALVE				
Constellation, Heritage, 3800, 4800, 4900, 5800, 5900, 6900		Main unit, all models with male O-Ring fitting, 12" capillary	A22-14420-1	ABP N83 308115
FAN				
Constellation, Heritage, 3800, 4800, 4900, 5800, 5900, 6900		Bergstrom, Kysor and Red Dot A/C, 6" diameter, CW	02-7075303	ABP N83 309101
FILTER				
4900, Constellation, Heritage	1995-05	Filter, Cab Air	WS101P	ABP N83 328335
Constellation, Heritage, 3800, 4800, 4900, 5800, 5900, 6900		Framed mesh filter, 11 5/8" wide x 5" high x 7/8" thick	60015-3418 RD-3-8777-0P	ABP N83 328293
HEATER CORE				
3800, 4800, 4900, 5800, 5900, 6900	1983-99	Heater Core	60003-4405	ABP N83 315350
3800, 4800, 4900, 5800, 5900, 6900	1996-99	Sleeper unit, Red Dot Heater A/C	3949252 60003-4404	ABP N83 315160
Constellation	2004-07	Main unit	RD-1-1965-0	ABP N83 315605
Constellation 4800, 4900, 5800, 5900	1993-03	Main unit, Red Dot Heater A/C (R-2560)	60004-3403	ABP N83 315480
Heritage 3800, 4800, 4900, 5800, 5900, 6900	1988-01	Heater Core	RD-1-0460-1 176280 60003-4405	ABP N83 315350
Heritage 4800, 4900, 5800, 5900	1985-03	Sleeper unit, Red Dot Heater A/C (R-2560)	RD-1-0665-0	ABP N83 315055
PRESSURE SWITCH				
3800, 4800, 4900, 5900, 6900	1987-09	Switch, Pressure, Trinary, NC	176225 RD-5-4625-0	ABP N83 322200
Constellation, Heritage, 3800, 4800, 4900, 5800, 5900, 6900	1987-09	Switch, Pressure, Trinary, NO	RD-5-4585-0 02-2750417	ABP N83 318009
RECEIVER DRIER				
3800, 4800, 4900, 5900, 6900	1988-93	O-Ring Type with Fuse Plug & Charge Port	176243 61506-3402-000	ABP N83 319565
Constellation 4800, 4900, 5800, 5900	1993-06	Main unit, 3" x 10", #6 male O-Ring, moisture indicator	61506-3406-000 088343-000	ABP N83 319315
Constellation, Heritage, 3800, 4800, 4900, 5800, 5900, 6900		2 3/4"x9 5/8", #6MOR in, #6MOR out, PRV, Top Glass, Side Port with Trinary Switch	RD-5-4632-0	ABP N83 319310
Constellation, Heritage, 3800, 4800, 4900, 5800, 5900, 6900		#6 male O-Ring, 2 3/4" x 10 5/8", without trinary switch	RD-5-6567-2	ABP N83 319130
Constellation, Heritage, 3800, 4800, 4900, 5800, 5900, 6900		#6 male O-Ring, 2 3/4" x 10", without binary switch	02-0707988	ABP N83 319004
Constellation, Heritage, 3800, 4800, 4900, 5800, 5900, 6900		#6 male O-Ring, 2 3/4" x 10", binary switch	02-7077922	ABP N83 319200
Constellation, Heritage, 3800, 4800, 4900, 5800, 5900, 6900		2 3/4"x9 5/8", #6MOR in, #6 MOR out, PRV, Side Glass, Top Port with Trinary Switch	02-7077984	ABP N83 319074

APPLICATIONS

MODEL	YEAR	DESCRIPTION	OEM P/N	ALLIANCE P/N
WESTERN STAR				
RECEIVER DRIER				
Constellation, Heritage, 3800, 4800, 4900, 5800, 5900, 6900		2 3/4"x9 5/8", #6MOR in, #6MOR out, PRV, Top Glass, Side Port with Trinary Switch	04-9041020	ABP N83 319310
Heritage 4800, 4900, 5800, 5900, 6900	1983-06	Main unit, 3" x 10", #6 male O-Ring, moisture indicator	RD-5-7517-0 176243 61506-3402	ABP N83 319047
RELAY				
Constellation, Heritage, 3800, 4800, 4900, 5800, 5900, 6900	1988-95	Relay, Blower, 12V, 20A/30A, Tab Mount, 5 Terminals	0332-204-125 150	ABP N83 320140
Constellation, Heritage, 3800, 4800, 4900, 5800, 5900, 6900	1988-95	Relay, Blower, 24V, 20A/30A, Tab Mount, 5 Terminal	0332-204-203	ABP N83 320280
Constellation, Heritage, 3800, 4800, 4900, 5800, 5900, 6900	1996-04	Relay, Blower, 12V, 30A/40A, Socket Mount	BOA-80-945-00-079 VF4-15F11-501	ABP N83 320140
SWITCH				
Constellation, Heritage, 3800, 4800, 4900, 5800, 5900, 6900		Switch, Rotary, 3 Speed, Long Shaft, 5 Terminal	BOA-80-926-00-109	ABP N83 322190
Constellation, Heritage, 3800, 4800, 4900, 5800, 5900, 6900	1993-00	Switch, Rotary, 3 Speed, Short Shaft, 5 Terminal	BOA-80-926-00-059	ABP N83 322150
Constellation, Heritage, 3800, 4800, 4900, 5800, 5900, 6900	All	Rotary switch, 3 speed, DP3T, 4 position, 5 terminal	176573	ABP N83 323018
THERMOSTAT				
4800, 4900, 5800, 5900	1985-09	Fixed, 24" Probe	60054-4401-000 3949291	ABP N83 323010
Constellation, Heritage, 3800, 4800, 4900, 5800, 5900, 6900	1972-78	Adjustable, 36" Probe	A22-15817A-001	ABP N83 323118
Constellation, Heritage, 3800, 4800, 4900, 5800, 5900, 6900	1983-97	Variable, Cable Controlled, 30" Capillary	02-7010174 RD-4226-0	ABP N83 323014
Constellation, Heritage, 3800, 4800, 4900, 5800, 5900, 6900	1987-96	Adjustable, 36" Probe	RD-4125-36	ABP N83 323118
WATER VALVE				
Constellation, Heritage, 3800, 4800, 4900, 5800, 5900, 6900		Cable Controlled, 5/8" Hose, STR-STR, Pull to Open	RD 5 4923 0 677413	ABP N83 324215
Constellation, Heritage, 3800, 4800, 4900, 5800, 5900, 6900		Cable Operated, Red Dot (5/8" to 3/4"), pull to open	RDH RD5 5300 1	ABP N83 324070

ELECTRICAL

SWITCHES

17



TOGGLE SWITCHES

SPECIFICATIONS

Listed in ascending order by dimension:

A=Base length **B**=Base width **C**=Flange to Blade End
D= Flange to Bezel Shaft Top **E**=Diameter-Thread **F**= Keyway

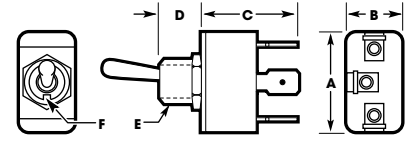

Dimensions						No. of				
A	B	C	D	E	F	Type/Description	Function	Terminals	Type	Alliance P/N
1 1/8	5/8	1 7/64	1/2	15/32-32UNS-2A	.072 x .038	SPST/Chrome	On - Off	2	1/4" male blade	ABP N83 322345
1 1/8	5/8	1 3/32	1/2	15/32-32UNS-2A	.072 x .038	SPDT/Black	On - Off - On	3	1/4" male blade	ABP N83 322185
1 5/16	3/4	1 1/4	1/2	15/32-32UNS-2A	.072 x .038	DPDT/Chrome	On - On - On	4	1/4" male blade	ABP N83 322340
1 5/16	3/4	1 1/4	1/2	15/32-32UNS-2A	.072 x .038	DPDT/Chrome	On - Off - On	6	1/4" male blade	ABP N83 322055
1 5/16	3/4	1 5/16	1/2	15/32-32UNS-2A	.068 x .035	DPDT/Black	On - Off - On	5	1/4" male blade	ABP N83 322375
1 5/16	3/4	1 11/32	1/2	15/32-32UNS-2A	.068 x .035	SPST/Black	On - Off	3	1/4" male blade	ABP N83 322275
1 1/2	1	1 1/4	1 3/4	Lever	Lever	SPST/Lever	Off - On - On - On	5	1/4" male blade	ABP N83 322005
1 3/4	3/4	1 1/2	7/8	Paddle	Paddle	SPDT/Safety	On - Off - On	3	1/4" male blade	ABP N83 322350
1 3/4	3/4	1 1/2	7/8	Paddle	Paddle	DPDT/Safety	On - Off - On	5	1/4" male blade	ABP N83 322355
1 15/16	1 11/16	1 3/16	1 25/32	Lever	Lever	DP4POS/Lever	Off - On - On - On	10	1/4" male blade	ABP N83 322060
				15/32-32UNS-2A		DPDT/Black	On - On - On	4	1/4" male blade	ABP N83 322170
				15/32-32UNS-2A		3PDT/Chrome	On - Off - On	9	1/4" male blade	ABP N83 322240
				15/32-32UNS-2A		SPST/Chrome	On - Off	4	1/4" male blade	ABP N83 322030
				15/32-32UNS-2A		DPDT/Chrome	On - On - On	4	1/4" male blade	ABP N83 322035
				15/32-32UNS-2A		DPDT/Chrome	On - Off - On	6	1/4" male blade	ABP N83 322040
				15/32-32UNS-2A		SPST/Black	On - Off	3	1/4" male blade	ABP N83 322050
				15/32-32UNS-2A		DP4POS/Black	Off - On - On - On	10	1/4" male blade	ABP N83 322430
				Lever	Lever	SPST /Bent Lever	Off - On - On - On	5	1/4" male blade	ABP N83 322003
				Lever	Lever	SPST/Lever	Off - On - On - On	5	1/4" male blade	ABP N83 322000
				Lever	Lever	4 Position/Lever	Off - Low - Med - Hi	4	1/4" male blade	ABP N83 322063
				Lever	Lever	DP4POS/Lever	Off - On - On - On	10	1/4" male blade	ABP N83 322067
				Lever	Lever	4 Position/Lever	Off - Low - Med - Hi	5	1/4" male blade	ABP N83 322361
				Lever	Lever	4 Position/Lever	Off - Low - Med - Hi	5	1/4" male blade	ABP N83 322631
				Lever	Lever	4 Position/Lever	Low - Med 1 - Med 2 - Hi	4	1/4" male blade	ABP N83 322013
				Lever	Lever	4 Position/Lever	Low - Med 1 - Med 2 - Hi	4	1/4" male blade	ABP N83 322113

Mounting nuts are 15/32 - 32 UNF-2B

18

ELECTRICAL

TOGGLE SWITCHES

ABP N83 322000

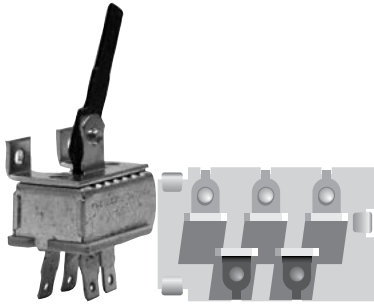

SPST Type
 Uses 71R4030 knob
 Function: OFF - ON - ON - ON
 5 Terminals

ABP N83 322003

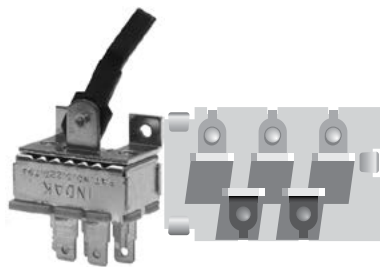

SPST Type with Bent Lever
 Uses 71R4030 knob
 OFF - ON - ON - ON
 5 Terminals

ABP N83 322005

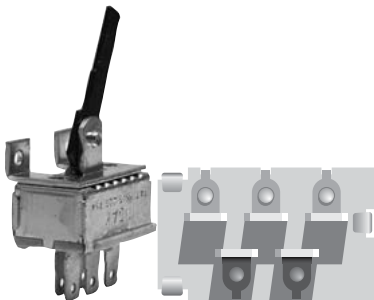

SPST Type
 Uses 71R4030 knob
 Function: OFF - ON - ON - ON
 5 Terminals

ABP N83 322013



Lever Switch
 4 Position Type
 Function: Lo - M1 - M2 - High
 5 Terminals

ABP N83 322030



SPST
 Chrome Toggle
 ON-OFF
 4 Terminals

ABP N83 322035



DPDT
 Chrome Toggle
 ON-ON-ON
 4 Terminals

ABP N83 322040



DPDT
 Chrome Toggle
 ON-OFF-ON
 6 Terminals

ABP N83 322050



SPST
 Black Toggle
 ON-OFF
 3 Terminals

ABP N83 322055

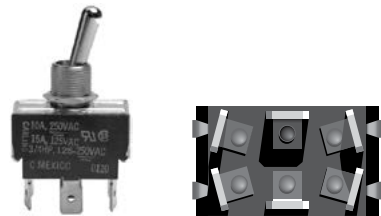

DPDT Type
 Chrome Toggle
 Function: ON - OFF - ON
 6 Terminals

ABP N83 322060

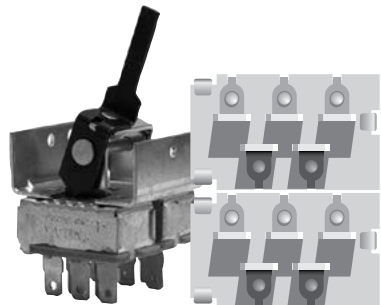

DP4POS Type
 Uses ABP N83 316055 knob
 Function: OFF - ON - ON - ON
 10 Terminals

TOGGLE SWITCHES

18

ELECTRICAL

ABP N83 322063

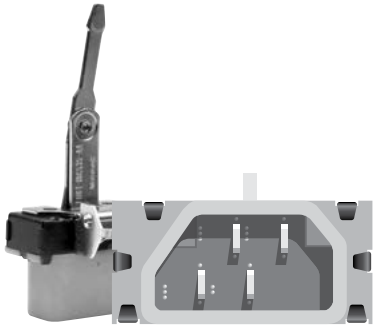

Freightner
Lever Switch, Single Pole,
4 Position Type - Uses ABP N83
316055 knob
Function: OFF - LOW - MED - HIGH
4 Terminals

ABP N83 322067

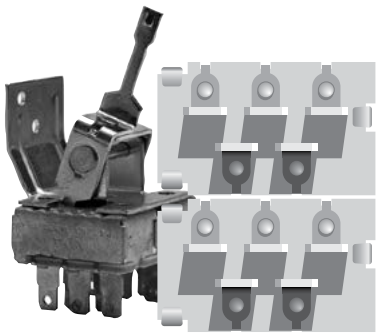

DP4POS Type
Function: OFF - ON - ON - ON
10 Terminals

ABP N83 322113



Lever Switch, Single Pole,
4 Position Type
Function: LOW - MED1 - MED2 -
HIGH
4 Terminal

ABP N83 322170

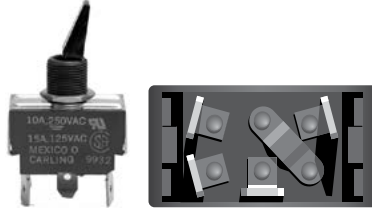

DPDT Type
Black Toggle
Function: ON - ON - ON
4 Terminals

ABP N83 322185

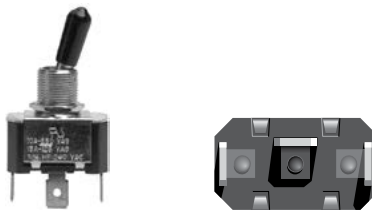

SPDT Type — Black Toggle
Function: ON - OFF - ON
3 Terminals

ABP N83 322240

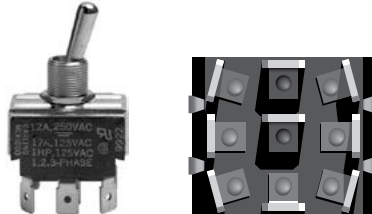

3PDT Type — Chrome Toggle
Function: ON - OFF - ON
9 Terminals

ABP N83 322275

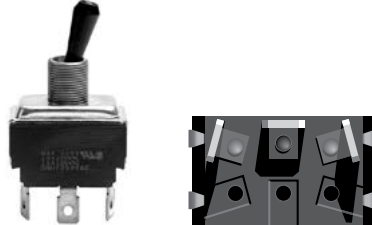

SPST Type — Black Toggle
Function: ON - OFF
3 Terminals

ABP N83 322340

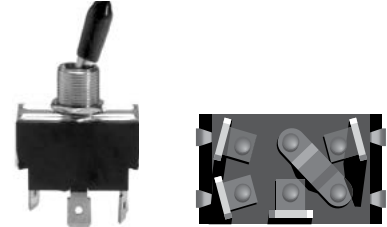

DPDT Type — Chrome Toggle
Function: ON - ON - ON
4 Terminals

ABP N83 322345

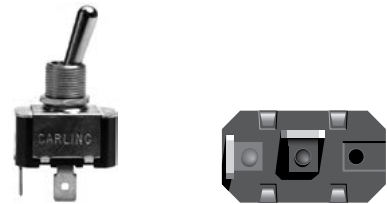

SPST Type — Chrome Toggle
Function: ON - OFF
2 Terminals

ABP N83 322350

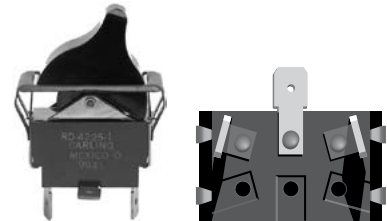

SPDT Type — Safety Toggle
Function: ON - OFF - ON
3 Terminals

ABP N83 322355

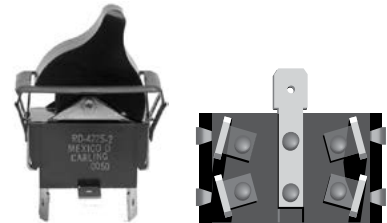

DPDT Type — Safety Toggle
Function: ON - OFF - ON
5 Terminals

TOGGLE SWITCHES

ABP N83 322375

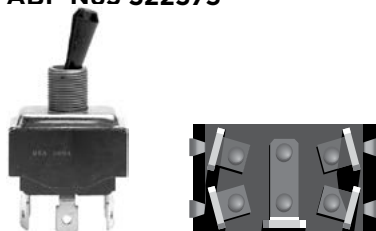

DPDT Type — Black Toggle
Function: ON - OFF - ON
5 Terminals

ABP N83 322430



DP - Black Toggle
OFF-ON-ON-ON
10 Terminals

ABP N83 322631



Lever Switch, Single Pole,
4 Position Type
Function: OFF - LOW - MED - HIGH
5 Terminals

ROCKER SWITCHES

SPECIFICATIONS

18

ELECTRICAL

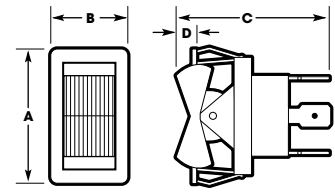

Listed in ascending order by dimension:

A=Base length **B**=Base width **C**=Overall Depth **D**=Flange to Rocker Height

Dimensions				Type	Rating	Function	No. of Terminals	Light		
A	B	C	D					Type	Illumination	Alliance P/N
$\frac{7}{8}$	$\frac{5}{8}$	1	$\frac{3}{8}$	SPST	12VDC, 15 amps	On-Off	3	$\frac{3}{4}$ " male blade	Blue	ABP N83 322226
$\frac{7}{8}$	$\frac{5}{8}$	1	$\frac{3}{8}$	SPST	12VDC	On-Off	3	$\frac{3}{4}$ " male blade	Green	ABP N83 322227
$\frac{7}{8}$	$\frac{5}{8}$	1	$\frac{3}{8}$	SPST	12VDC	On-Off	3	$\frac{3}{4}$ " male blade	White	ABP N83 322228
$\frac{7}{8}$	$\frac{5}{8}$	1	$\frac{3}{8}$	SPST	12VDC	Off-On	2	$\frac{3}{4}$ " male blade	None	ABP N83 322229
$1\frac{1}{8}$	$\frac{5}{8}$	$1\frac{3}{4}$	$\frac{3}{4}$	SPDT	12VDC 15 amps	On-Off-On	3	$\frac{3}{4}$ " male blade	None	ABP N83 322320
$1\frac{1}{16}$	$\frac{7}{8}$	$1\frac{1}{8}$	$\frac{3}{8}$	SPST	12VDC	On-On	2	$\frac{3}{4}$ " male blade	None	ABP N83 322215
$1\frac{1}{16}$	$\frac{7}{8}$	$1\frac{1}{8}$	$\frac{3}{8}$	DPST with jumper	12VDC	On-On	5	$\frac{3}{4}$ " male blade	None	ABP N83 322180
$1\frac{1}{16}$	$\frac{7}{8}$	$1\frac{1}{8}$	$\frac{3}{8}$	DPDT with jumper	12VDC 15 amps	On-Off-On	5	$\frac{3}{4}$ " male blade	None	ABP N83 322325
$1\frac{1}{16}$	$\frac{7}{8}$	$1\frac{1}{8}$	$\frac{3}{8}$	DPDT	12VDC	On-Off-On	6	$\frac{3}{4}$ " male blade	None	ABP N83 322205
2	1	2	$\frac{1}{2}$	SPDT	12VDC	On-Off-On*	4	$\frac{3}{4}$ " male blade	Red	ABP N83 322222
2	1	2	$\frac{1}{2}$	DPDT	12VDC	Off-On-On	4	$\frac{3}{4}$ " male blade	Blue	ABP N83 322223
2	1	2	$\frac{1}{2}$	DPDT	12VDC	On-On-On	4	$\frac{3}{4}$ " male blade	None	ABP N83 322224
2	1	2	$\frac{1}{2}$	DPDT	24VDC	Off-On-On	4	$\frac{3}{4}$ " male blade	Blue	ABP N83 322232
2	1	2	$\frac{1}{2}$	SPST	24VDC	Off-On*	4	$\frac{3}{4}$ " male blade	White	ABP N83 322234
$2\frac{7}{8}$	$1\frac{5}{16}$	$1\frac{1}{8}$	$\frac{3}{8}$		12VDC		8	$\frac{3}{4}$ " male blade	Blue	ABP N83 322233

ABP N83 322180

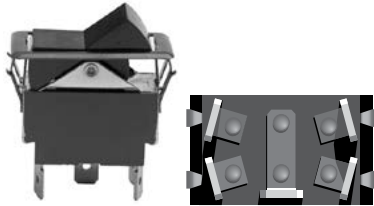

DPST Type with Jumper
Function: On-On
5 Terminals

ABP N83 322215

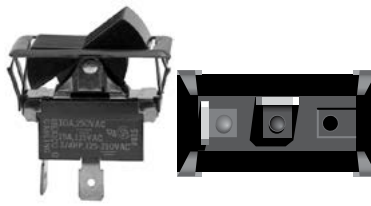

SPST Type
Function: On-On
2 Terminals

ABP N83 322223



DPDT Type — Function: Off-On-On
4 Terminals 12 VDC
Blue Light

ABP N83 322205

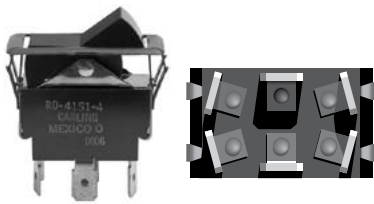

DPDT Type
Function: On-Off-On
6 Terminals

ABP N83 322222

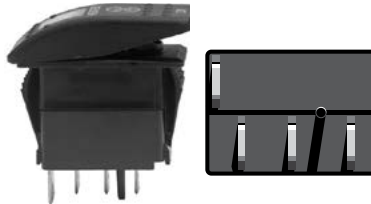

SPDT Type — Function: On-Off-On*
4 Terminals 12 VDC
Red Light

ABP N83 322224



DPDT Type — Function: Off-On-On
4 Terminals 12 VDC

ROCKER SWITCHES

ABP N83 322226



SPST Type — Function: On-Off
3 Terminals 12 VDC
Blue Light — 15 amps

ABP N83 322227



SPST Type — Function: On-Off
3 Terminals 12 VDC
Green Light

ABP N83 322228

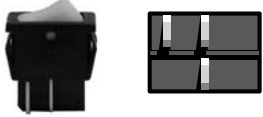

SPST Type — Function: On-Off
3 Terminals 12 VDC
White Light

ABP N83 322229

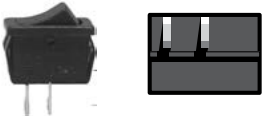

SPST Type — Function: Off-On
2 Terminals 12/24 VDC

ABP N83 322232

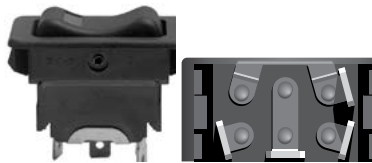

DPDT Type — Function: Off-On-On
4 Terminals 24 VDC
Blue Light

ABP N83 322233



8 Terminals 12 VDC
Blue Light

ABP N83 322234

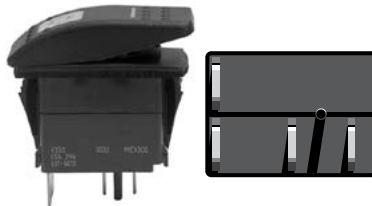

SPST — Function: Off-On*
4 Terminals 24 VDC
White Light
OE Cat #107-6070

ABP N83 322320

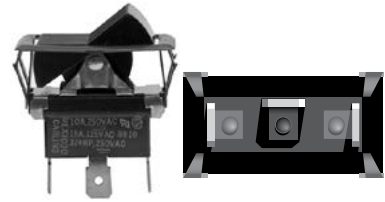

SPDT Type — Function: On-Off-On
3 Terminals, 12 VDC
15 amps

ABP N83 322325

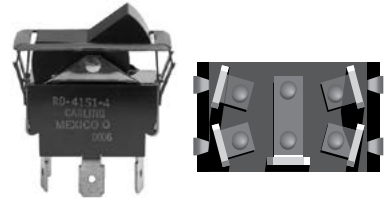

DPDT Type with Jumper
Function: On-Off-On
5 Terminals, 12 VDC
15 amps

TYPICAL A/C PLUMBING SCHEMATIC

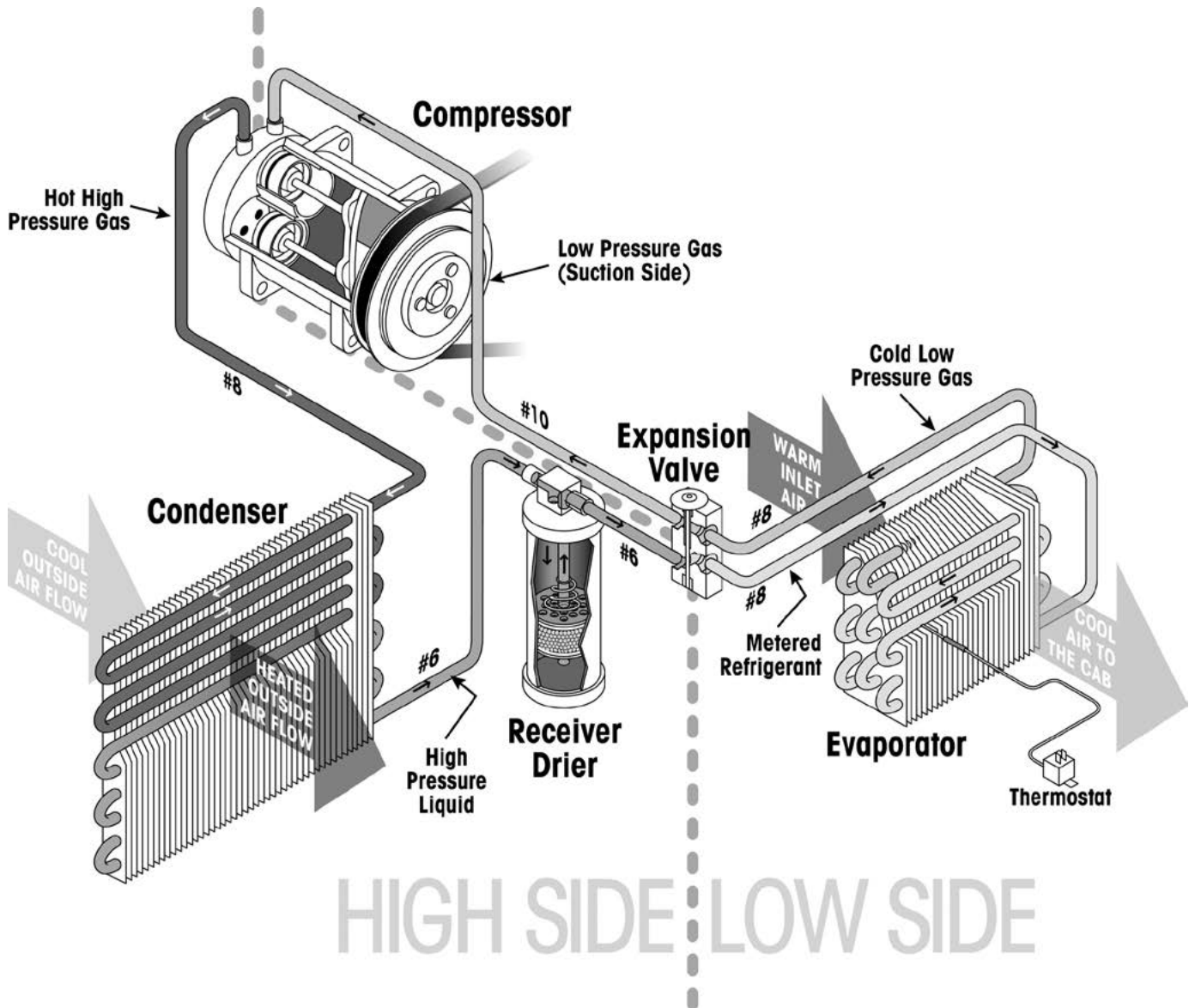

Air Conditioner components are connected together to illustrate system operation. The components shown are not to scale. The refrigerant and refrigerant oil are clear in color and not visible in this drawing; however, we've attempted to suggest temperature variants through the use of values of gray in the pipeline. The small arrows inside the components and connecting hoses show the direction of refrigerant flow (refrigerant circuit).

**Speak to your dealer about
Alliance Truck Parts.**

AllianceTruckParts.com.au





FIND YOUR NEAREST LOCATION AT ALLIANCETRUCKPARTS.CO.NZ



Mercedes-Benz is a registered trademarks of Daimler AG, Stuttgart Germany. Freightliner and Alliance Truck Parts are registered trademarks of Daimler Trucks North America LLC, all distributed by Daimler Truck and Bus Australia Pacific Pty Ltd. ACN 618 413 282 / NZCN 8039364. Specifications are subject to change without notice.

Copyright © Daimler Truck and Bus Australia Pacific Pty Ltd. All rights reserved.

DAIMLER TRUCK